

Service

DVP3310/96

Service

Service



Service Manual

TABLE OF CONTENTS

	Page
. Technical Specifications.....	1-2
. Safety Instruction, Warning & Notes.....	1-3
. DFU Instruction.....	2-1
. Mechanical and Dismantling Instructions.....	3-1
. Software Version & Upgrades, Region Code Change.....	4-1
. Trouble Shooting Chart.....	5-1
. Wiring Diagram.....	6-1
. Electrical Diagrams and Print-layouts.....	7-1
. Set Mechanical Exploded view & Part list.....	8-1
. Revision List.....	9-1

©Copyright 2009 Philips Consumer Electronics B.V. Eindhoven, The Netherlands
 All rights reserved. No part of this publication may be reproduced, stored in a retrieval system or transmitted, in any form or by any means, electronic, mechanical, photocopying, or otherwise without the prior permission of Philips.



Specification

Note

- Specification and design are subject to change without notice.

Accessories supplied

- Remote control and batteries
- Audio/video cables

Playback media

- DVD-Video, Video CD/SVCD, Audio CD, CD-R/CD-RW, DVD+R/+RW, DVD-R/-RW, Picture CD, MP3-CD, WMA-CD

TV standard

- Number of lines:
 - 625 (PAL/50Hz); 525 (NTSC/60Hz)
- Playback: Multi-standard (PAL/NTSC)

Video performance

- Video DAC: 14 bits, 108 MHz
- Y Pb Pr: 0.7 V_{pp} ~ 75 ohm
- Video output: 1 V_{pp} ~ 75 ohm

Video format

- Digital compression:
 - MPEG 2: DVD/SVCD
 - MPEG 1: VCD
- Horizontal resolution:
 - DVD: 720 pixels (50 Hz); 720 pixels (60 Hz)
 - VCD: 352 pixels (50 Hz); 352 pixels (60 Hz)
- Vertical resolution:
 - DVD: 576 pixels (50 Hz); 480 pixels (60 Hz)
 - VCD: 288 lines (50 Hz); 240 lines (60 Hz)

Audio performance

- DA converter: 24 bits, 192 kHz
- Frequency response:
 - DVD: 4 Hz - 22 kHz (48 kHz); 4 Hz - 44 kHz (96 kHz)
 - SVCD: 4 Hz - 20 kHz (44.1 kHz); 4 Hz - 22 kHz (48 kHz)

- CD/VCD: 4 Hz - 20 kHz (44.1 kHz)
- Signal-Noise (1 kHz): > 100 dB (A-weighted)
- Dynamic range (1 kHz): > 80 dB (A-weighted)
- Crosstalk (1 kHz): > 100 dB
- Distortion/noise (1 kHz): > 85 dB
- MPEG MP3: MPEG Audio L3

Audio format

- Digital:
 - MPEG/AC-3/PCM: Compressed digital (16, 20, 24 bits fs, 44.1, 48, 96 kHz)
 - MP3 (ISO 9660): 96, 112, 128, 256 kbps & variable bit rate fs, 32, 44.1, 48 kHz
- Analog sound stereo
- Dolby surround compatible downmix from Dolby Digital multi-channel sound

Connections

- Y Pb Pr output: Cinch 3x
- Video output: Cinch (yellow)
- Audio output (L+R): Cinch (white/red)
- Digital output:
 - 1 coaxial: IEC60958 for CDDA/LPCM; IEC61937 for MPEG 1/2, Dolby Digital

Main unit

- Dimensions (w x h x d): 360 x 37 x 209 (mm)
- Net Weight: approximately 1.3 kg

Power

- Power supply rating: 110 V - 240 V; 50/60 Hz
- Power consumption: < 10 W
- Power consumption in standby mode: < 1 W

Laser specification

- Type: Semiconductor laser InGaAlP (DVD), AlGaAs (CD)
- Wave length: 655 nm (DVD), 790 nm (CD)
- Output Power: 10 mW (DVD), 5 mW (VCD/CD)
- Beam divergence: 60 degrees

Safety instruction, Warning & Notes

Safety instruction

1. General safety

Safety regulations require that during a repair:

- . Connect the unit to the mains via an isolation transformer.
- . Replace safety components indicated by the symbol , only by components identical to the original ones. Any other component substitution (other than original type) may increase risk of fire or electrical shock hazard.

Safety regulations require that after a repair, you must return the unit in its original condition. Pay, in particular, attention to the following points:

- . Route the wires/cables correctly, and fix them with the mounted cable clamps.
- . Check the insulation of the mains lead for external damage.
- . Check the electrical DC resistance between the mains plug and the secondary side:
 - 1) Unplug the mains cord, and connect a wire between the two pins of the mains plug.
 - 2) Set the mains switch the "on" position (keep the mains cord unplug).
 - 3) Measure the resistance value between the mains plug and the front panel, controls, and chassis bottom.
 - 4) Repair or correct unit when the resistance measurement is less than 1M Ω .
 - 5) Verify this, before you return the unit to the customer/user (ref. UL-standard no. 1492).
 - 6) Switch the unit "off", and remove the wire between the two pins of the mains plug.

2.Laser safety

This unit employs a laser. Only qualified service personnel may remove the cover, or attempt to service this device (due to possible eye injury).

Laser device unit

Type	: Semiconductor laser GaAlAs
Wavelength	: 650nm (DVD)
	: 780nm (VCD/CD)
Output power	: 7mW (DVD)
	: 10mW (DVD /CD)

Beam divergence: 60 degree

Note: Use of controls or adjustments or performance of procedure other than those specified herein, may result in hazardous radiation exposure. Avoid direct exposure to beam.

Warning

1. General

. All ICs and many other semiconductors are susceptible to electrostatic discharges (ESD). Careless handling during repair can reduce life drastically. Make sure that, during repair, you are at the same potential as the mass of the set by a wristband with resistance. Keep components and tools at this same potential. Available ESD protection equipment:

1) Complete kit ESD3 (small tablemat, wristband, connection box, extension cable and earth cable)
4822 310 10671.

2) Wristband tester 4822 344 13999.

. Be careful during measurements in the live voltage section. The primary side of the power supply, including the heat sink, carries live mains voltage when you connect the player to the mains (even when the player is "off"!). It is possible to touch copper tracks and/or components in this unshielded primary area, when you service the player. Service personnel must take precautions to prevent touching this area or components in this area. A "lighting stroke" and a stripe-marked printing on the printed wiring board, indicate the primary side of the power supply.

. Never replace modules, or components, while the unit is "on".

2. Laser

. The use of optical instruments with this product, will increase eye hazard.

. Only qualified service personnel may remove the cover or attempt to service this device, due to possible eye injury.

. Repair handling should take place as much as possible with a disc loaded inside the player.

. Text below is placed inside the unit, on the laser cover shield:

<p>CAUTION: VISIBLE AND INVISIBLE LASER RADIATION WHEN OPEN, AVOID EXPOSURE TO BEAM.</p>

Notes: Manufactured under licence from Dolby Laboratories. The double-D symbol is trademarks of Dolby Laboratories, Inc. All rights reserved.

Notes

Lead-Free requirement for service

IDENTIFICATION:

Regardless of special logo (not always indicated) 

One must treat all sets from 1.1.2005 onwards, according next rules.

Important note: In fact also products a little older can also be treated in this way as long as you avoid mixing solder-alloys (leaded/ lead-free). So best to always use SAC305 and the higher temperatures belong to this.

Due to lead-free technology some rules have to be respected by the workshop during a repair:

- Use only lead-free solder alloy Philips SAC305 with order code 0622 149 00106. If lead-free solder-paste is required, please contact the manufacturer of your solder-equipment. In general use of solder-paste within workshops should be avoided because paste is not easy to store and to handle.
 - Use only adequate solder tools applicable for lead-free solder alloy. The solder tool must be able
 - To reach at least a solder-temperature of 400°C,
 - To stabilize the adjusted temperature at the solder-tip
 - To exchange solder-tips for different applications.
 - Adjust your solder tool so that a temperature around 360°C – 380°C is reached and stabilized at the solder joint. Heating-time of the solder-joint should not exceed ~ 4 sec. Avoid temperatures above 400°C otherwise wear-out of tips will rise drastically and flux-fluid will be destroyed. To avoid wear-out of tips switch off un-used equipment, or reduce heat.
 - Mix of lead-free solder alloy / parts with leaded solder alloy / parts is possible but PHILIPS recommends strongly to avoid mixed solder alloy types (leaded and lead-free). If one cannot avoid, clean carefully the solder-joint from old solder alloy and re-solder with new solder alloy (SAC305).
- Use only original spare-parts listed in the Service-Manuals. Not listed standard-material (commodities) has to be purchased at external companies.
 - Special information for BGA-ICs:
 - always use the 12nc-recognizable soldering temperature profile of the specific BGA (for de-soldering always use highest lead-free temperature profile, in case of doubt)
 - lead free BGA-ICs will be delivered in so-called 'dry-packaging' (sealed pack including a silica gel pack) to protect the IC against moisture. After opening, dependent of MSL-level seen on indicator-label in the bag, the BGA-IC possibly still has to be baked dry. This will be communicated via AYS-website.
Do not re-use BGAs at all.
 - For sets produced before 1.1.2005, containing leaded soldering-tin and components, all needed spare-parts will be available till the end of the service-period. For repair of such sets nothing changes.
 - On our website:
 - www.atyourservice.ce.Philips.com**

You find more information to:

BGA-de-/soldering (+ baking instructions)

Heating-profiles of BGAs and other ICs used in Philips-sets

You will find this and more technical information within the "magazine", chapter "workshop news".

For additional questions please contact your local repair-helpdesk.

Product overview

Main unit

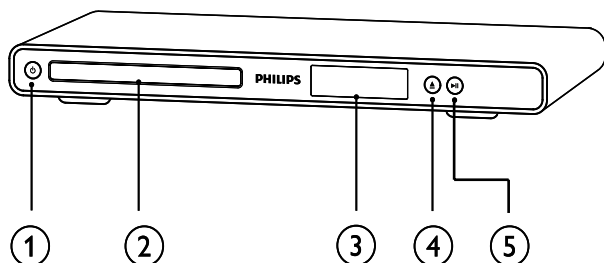

- ① **⏻ (Standby-On)**
 - Turns on the DVD player or switches to standby mode.
- ② **Disc compartment**
- ③ **Display panel**
- ④ **▲ (Open/Close)**
 - Opens or closes the disc compartment.
- ⑤ **▶|| (Play/Pause)**
 - Starts, pauses or resumes disc play.

Remote control

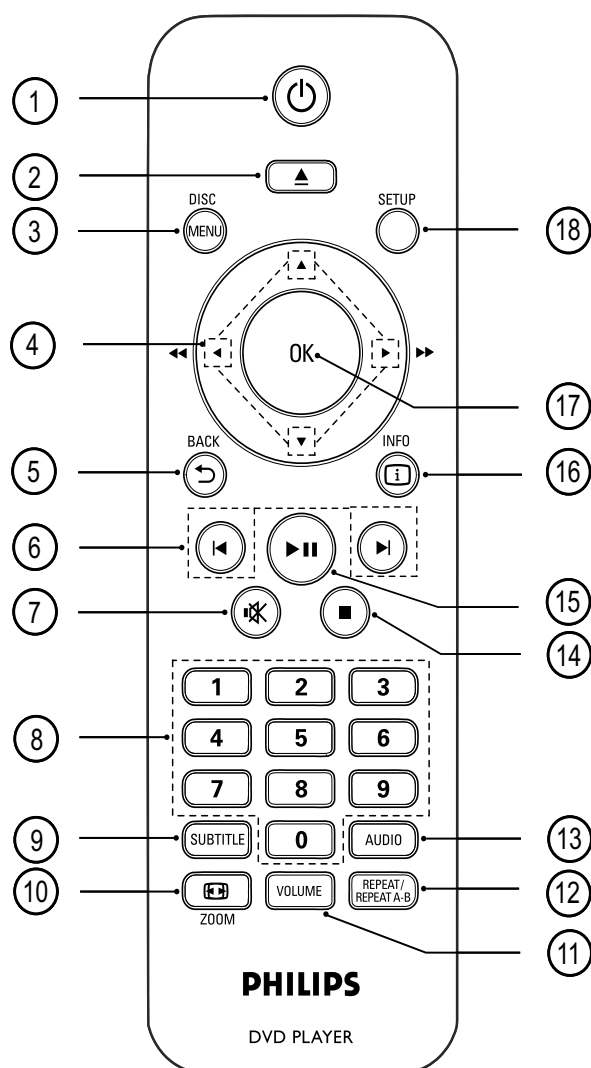

- ① **⏻ (Standby-On)**
 - Turns on the DVD player or switches to standby mode.
- ② **▲ (Open/Close)**
 - Opens or closes the disc compartment.
- ③ **DISC MENU**
 - Accesses or exits the disc menu.
 - For VCD and SVCD, turns PBC (playback control) on or off in PBC mode.
- ④ **▲▼◀▶ (Navigation buttons)**
 - Navigates through the menus.

- Searches fast-forward (right) or fast-backward (left). Press repeatedly to change the search speed.
- Searches slow-forward (up) or slow-backward (down). Press repeatedly to change the search speed.

⑤ **BACK**

- Returns to the previous menu.
- For DVD, navigates to title menu.
- For VCD version 2.0 or SVCD with PBC turned on, returns to the menu.

⑥ / **(Previous/Next)**

- Skips to the previous or next title, chapter, or track.
- Press and hold for fast-backward or fast-forward search.

⑦ **(Mute)**

- Mutes or restores audio output.

⑧ **Numeric buttons**

- Selects an item to play.

⑨ **SUBTITLE**

- Selects the subtitle language on a disc.

⑩ **ZOOM**

- Fits the picture format to the TV screen.
- Zooms in or out of the picture.

⑪ **VOLUME**

- Displays the current volume level and use left or right navigation buttons to set the volume level between 0 ~ 20.

⑫ **REPEAT/ REPEAT A-B**

- Toggles between various repeat modes.
- Marks the section for repeat play, or turns off repeat mode.

⑬ **AUDIO**

- Selects an audio language or channel on a disc.

⑭ **(Stop)**

- Stops disc play.

⑮ **(Play/Pause)**

- Starts, pauses or resumes disc play.

⑯ **INFO**

- For discs, displays information about the current status or the disc.
- For slideshows, displays a thumbnail view of photo files.

⑰ **OK**

- Confirms an entry or selection.

⑱ **SETUP**

- Accesses or exits the setup menu.

Mechanical and Dismantling Instructions

Dismantling Instruction

Detailed information please refer to the model set.

The following guidelines show how to dismantle the player.

Step1: Remove 5 screws around the Top Cover, and then remove the Top Cover (Figure 1).



Figure 1

Step2: If it is necessary to dismantle Loader or Front Panel, the Front door should be removed first. (Figure 2)

Note: Make sure to operate gently otherwise the guider would be damaged.



Please kindly note that dismantle the front door assembly carefully to avoid damage tray and the front door.

Figure 2

Mechanical and Dismantling Instructions

Dismantling Instruction

Detailed information please refer to the model set.

Step3: If the tray can't open in normal way, you can make it through the instruction as below (Figure 3).
Note: Make sure to operate gently otherwise the guider would be damaged.



Figure 3

Step4: Dismantling Front Panel, disconnect the connectors (XP5, XP6, XP7), need release 4 snaps of Front Panel and 2 snaps of bottom cabinet , then gently pull the Panel out from the set. (Figure 4 - Figure 6)

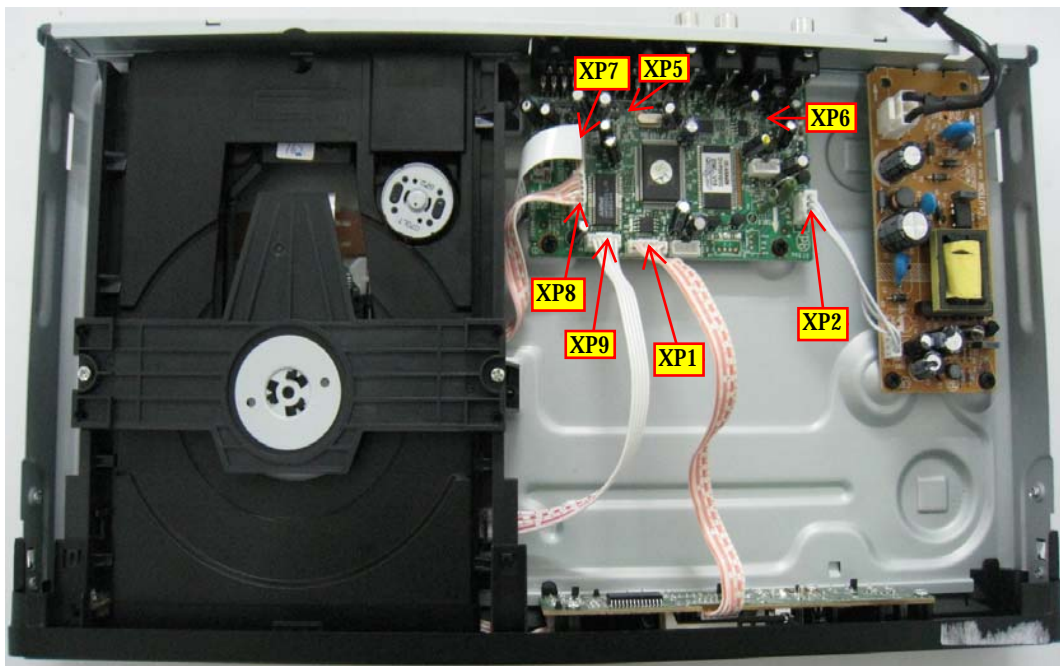

Figure 4

Mechanical and Dismantling Instructions

Dismantling Instruction

Detailed information please refer to the model set.

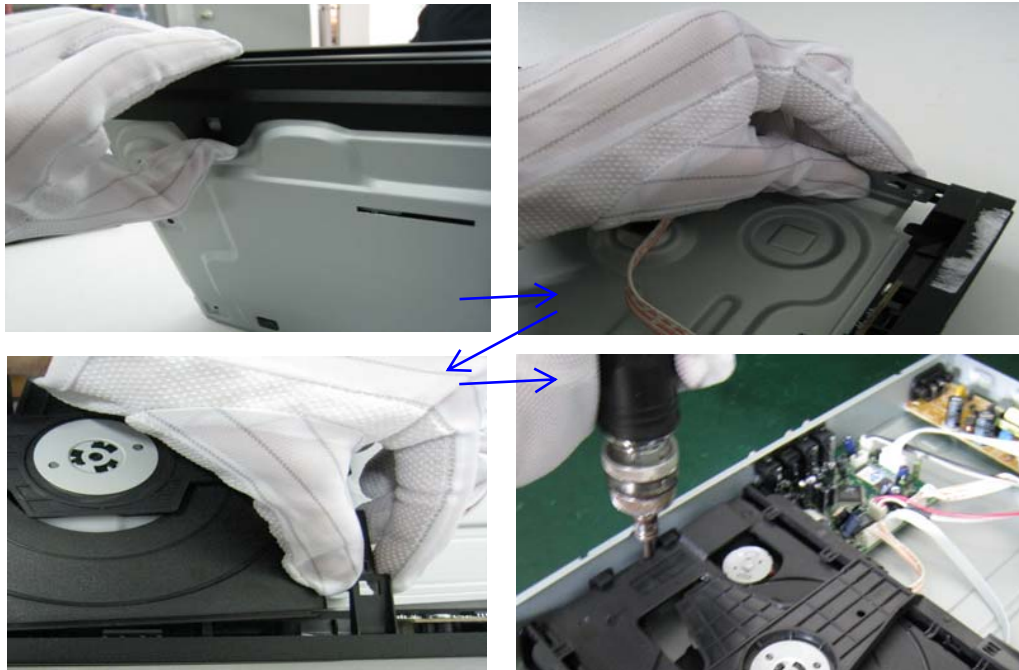

Figure 5

Step5: Dismantling Loader, disconnect the 3 connectors (XP2, XP3, XP4) aiming in the below figure, and remove 1 screw that connects the loader and the bottom cabinet. (Figure 5 & 6)

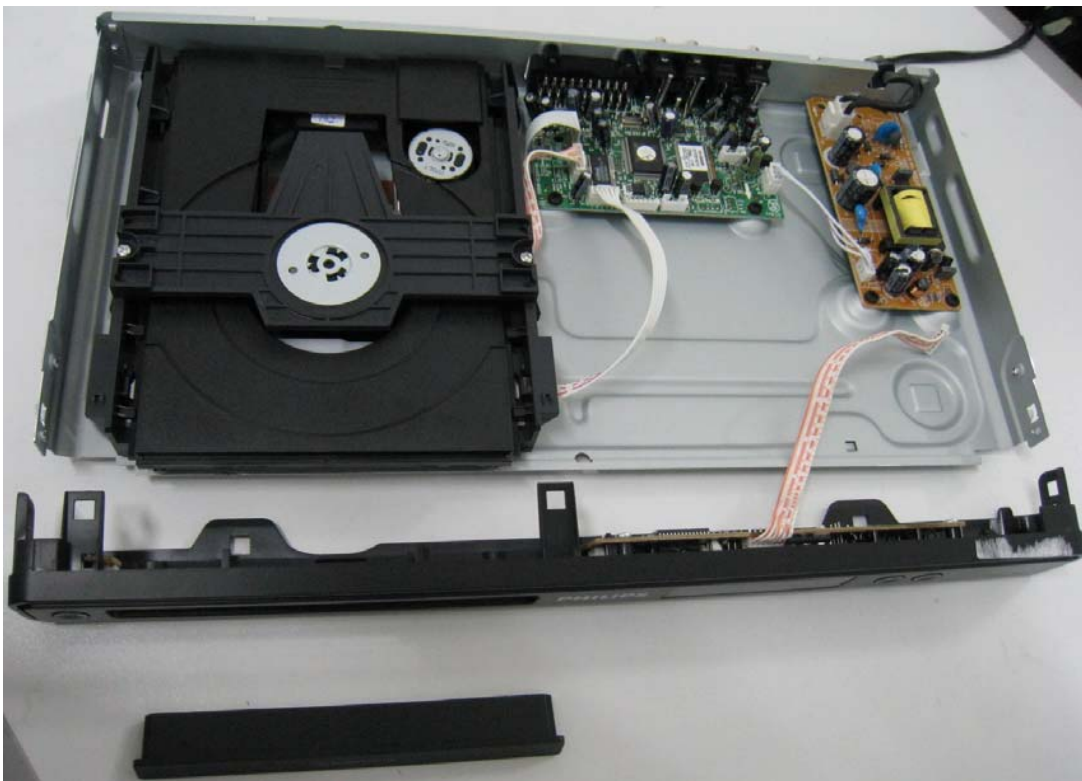

Figure 6

Mechanical and Dismantling Instructions

Dismantling Instruction

Detailed information please refer to the model set.

Step6: Dismantling Main Board, first disconnect the connector (XP1), and then remove 4 screws. (Figure 7)

Step7: Remove the 2 screws on Power Board to dismantle the Power Board. (Figure 7)

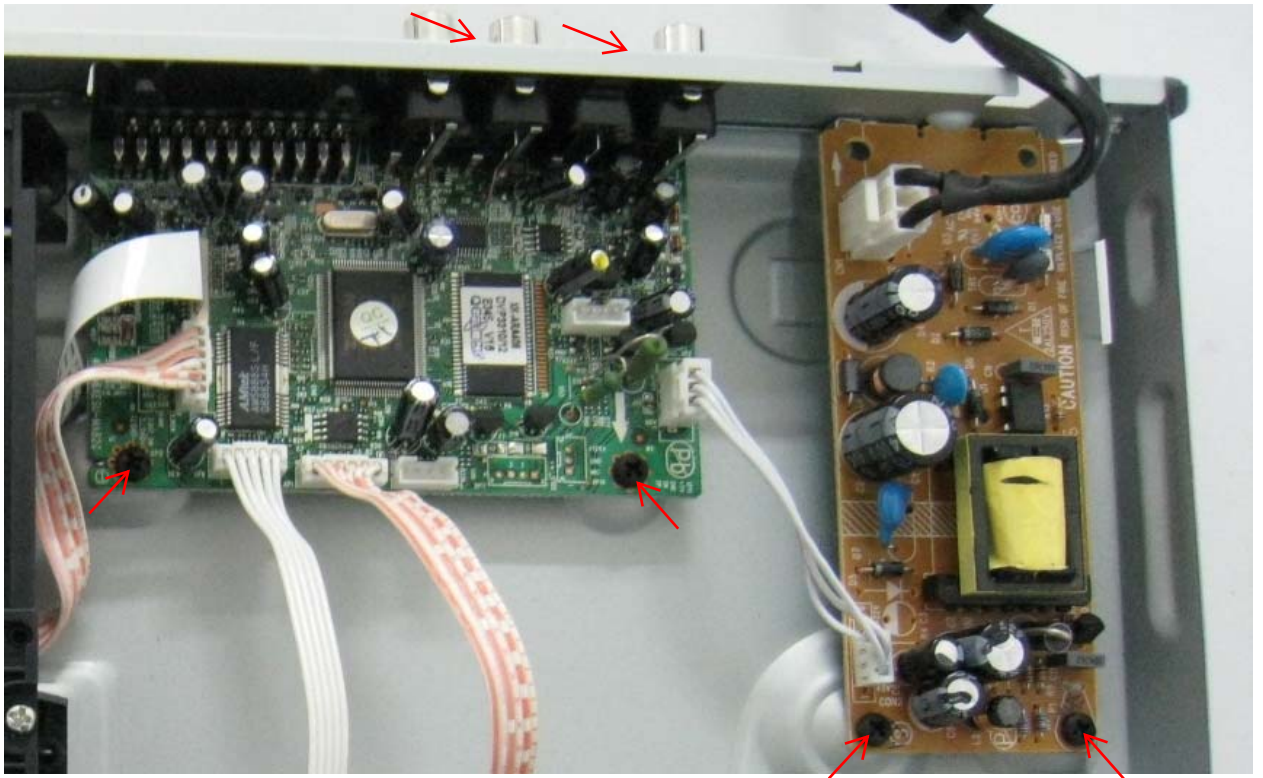

Figure 7

Software upgrade

How to upgrade the software

- 1) Burn the data onto a blank CD-R or RW disc.

A. Procedure for software upgrade:

- 1) Power on the set and insert the prepared Upgrade CDR.
- 2) The set will start reading disc & response with the following display TV screen:

Firmware Upgrade Erase and program.

Select to start upgrade.

- 3) Press <OK> button to confirm, then screen will display :

Firmware Upgrade Programming, Please Wait...

Do not Switch the Player Off !

- 4) The upgraded disc will automatically out when files copying complete, then take out the disc.
- 5) About 1 minute later, the tray will automatically close when upgrading complete.

B. Read out the Firmware version to confirm the upgrading

- 1) Power on the set and Open the tray door.
- 2) Press <9><6><6>button to check the software information.

The software version and other information are display on the TV screen as follows:

BE Version: DVP33XX_XX.XX

FE Version: XXXX.XXXXXX

DSP Version: DSP.XX

Region Code: X

Caution: The set must not be power off during upgrading, Otherwise the Main board will be damaged entirely.

Region Code Change

- 1) Power on the set and open the tray door;
- 2) Press "9" "8" "7" "9" and press the region code number (0-6) on the remote control.

Notes:restart after above steps.

Spindle motor does not move

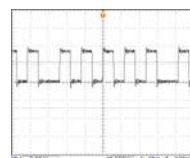
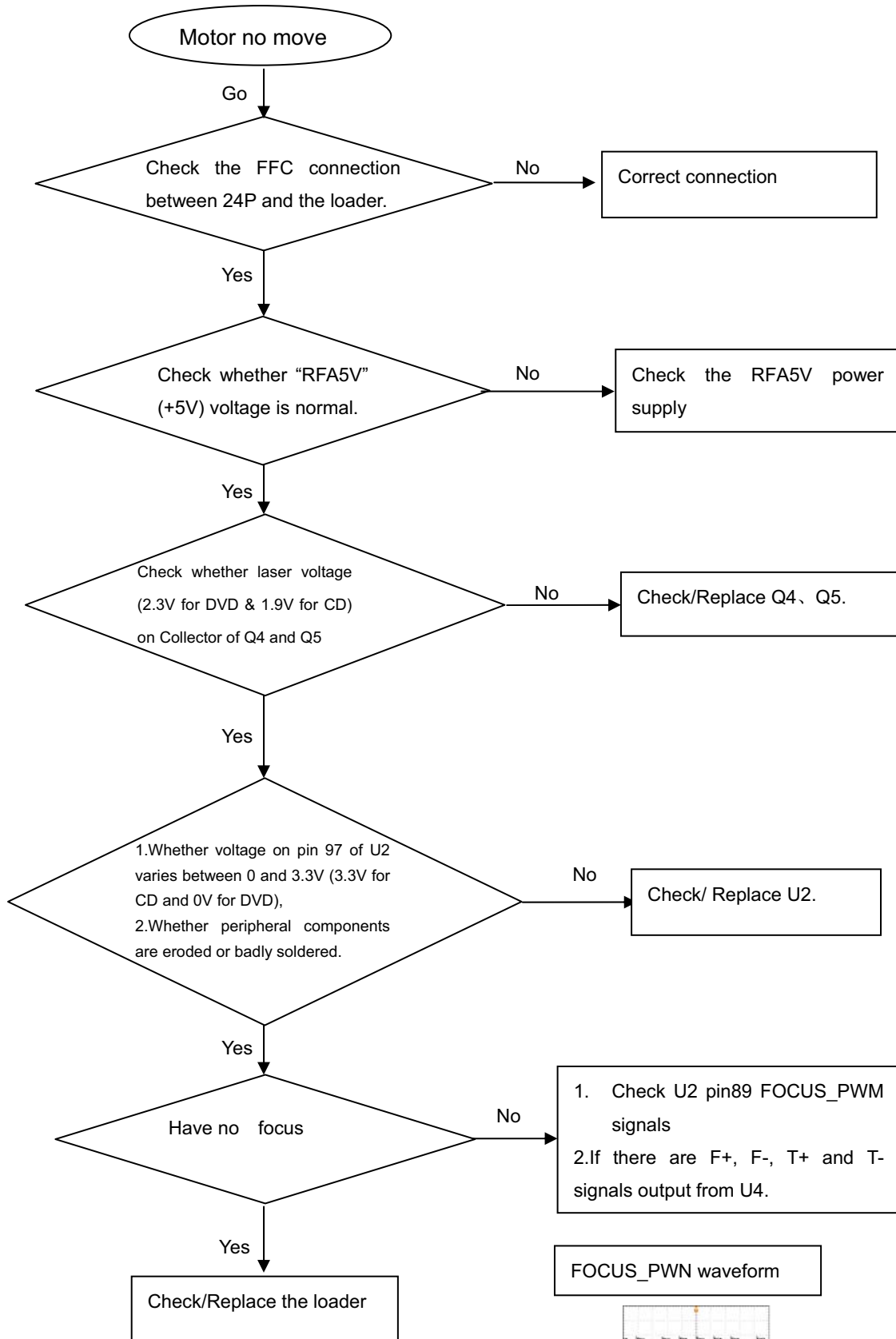

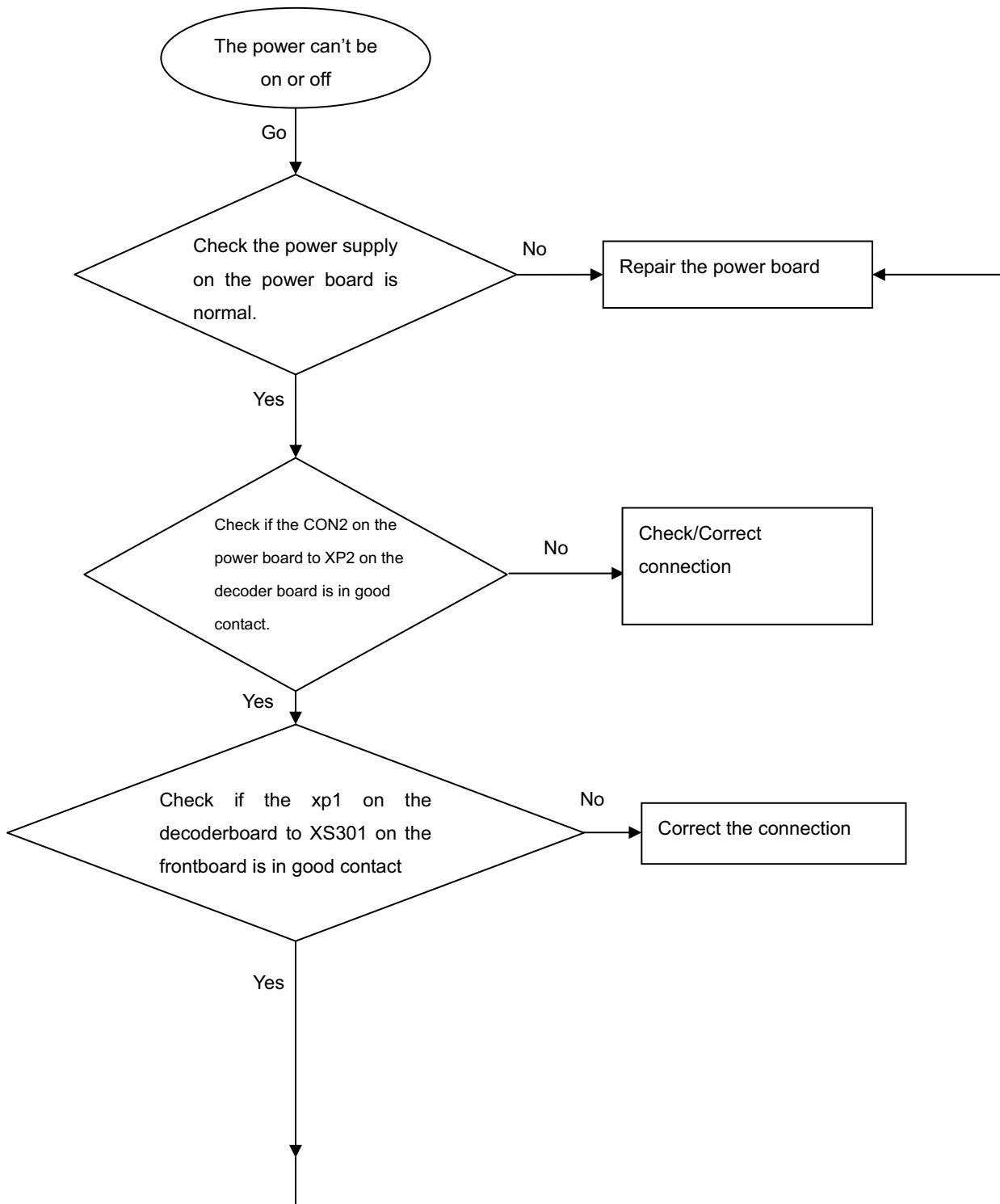
The power can not be on or off

All output voltages on the power board is 0V or deviated.

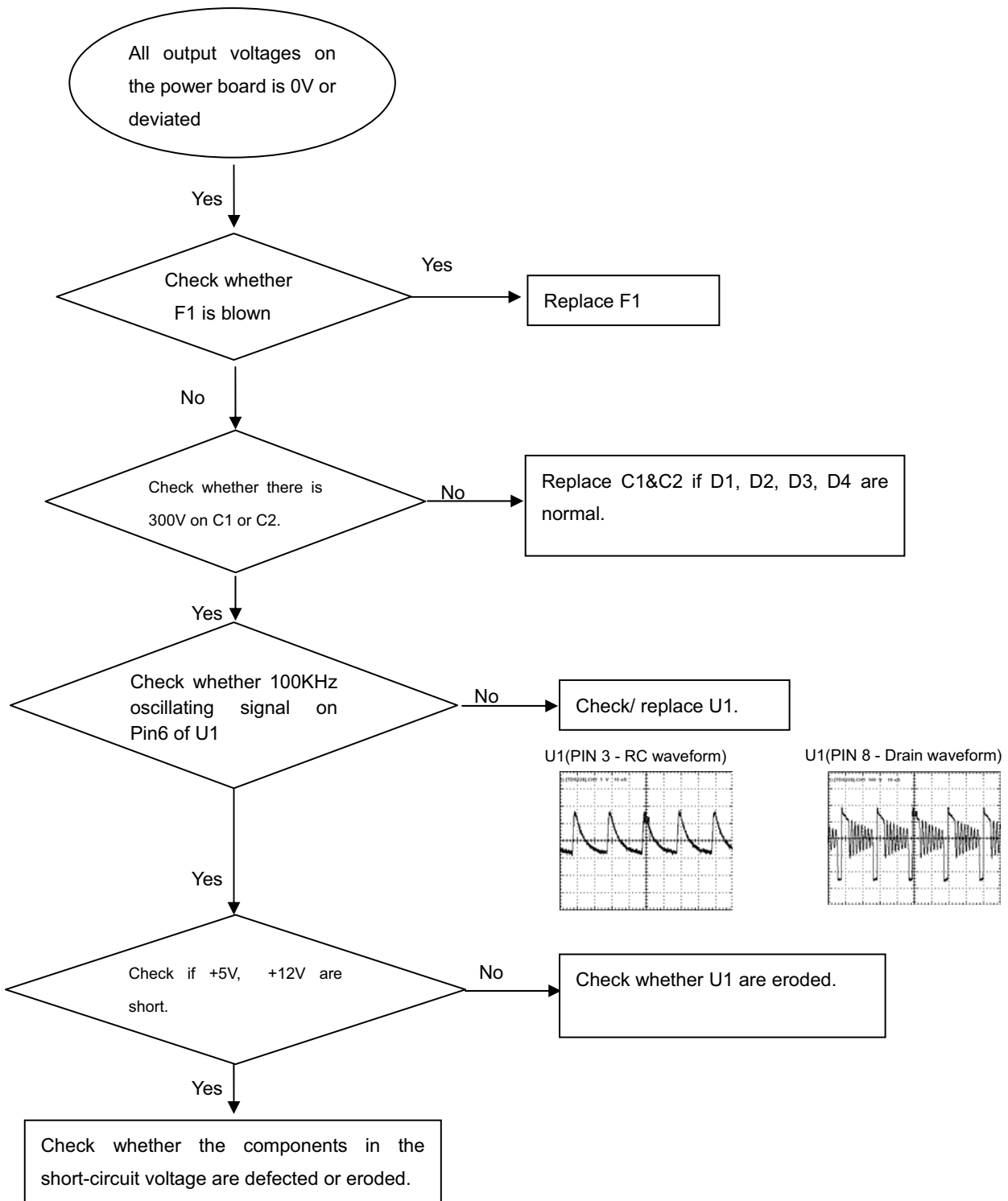

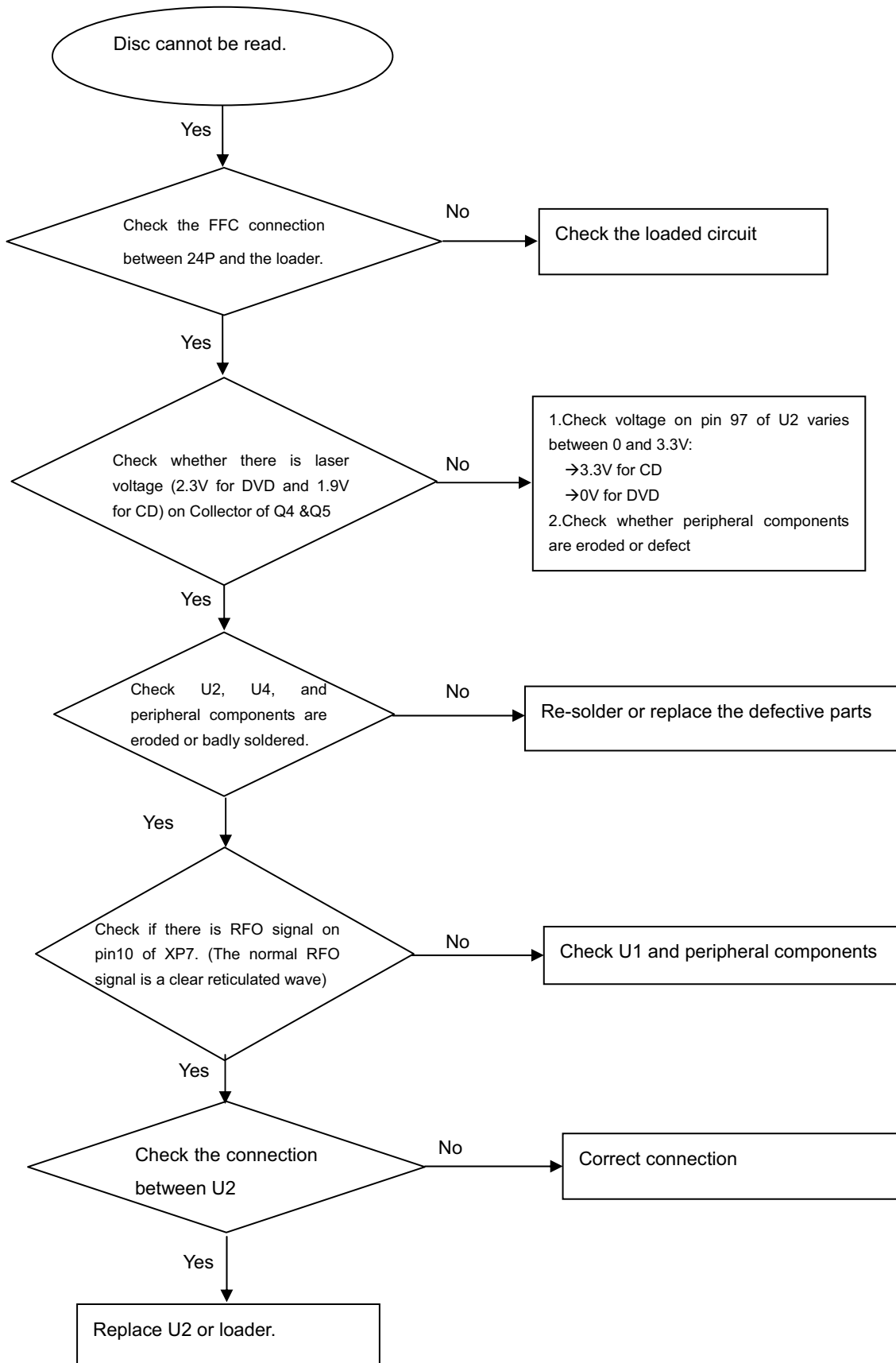
Disc cannot be read.

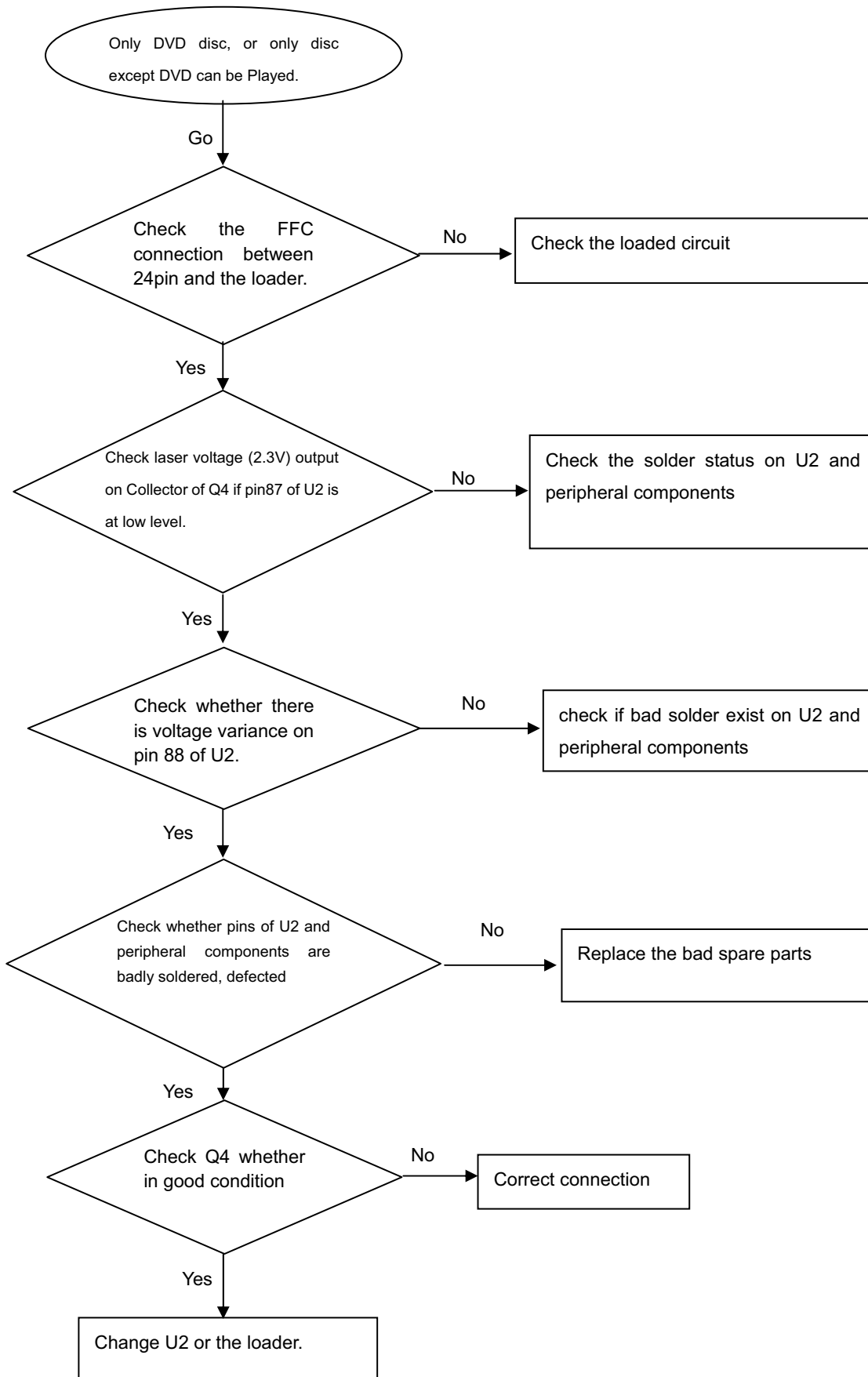
Only DVD disc or only disc except DVD can be played

No display on LED, and buttons do not work

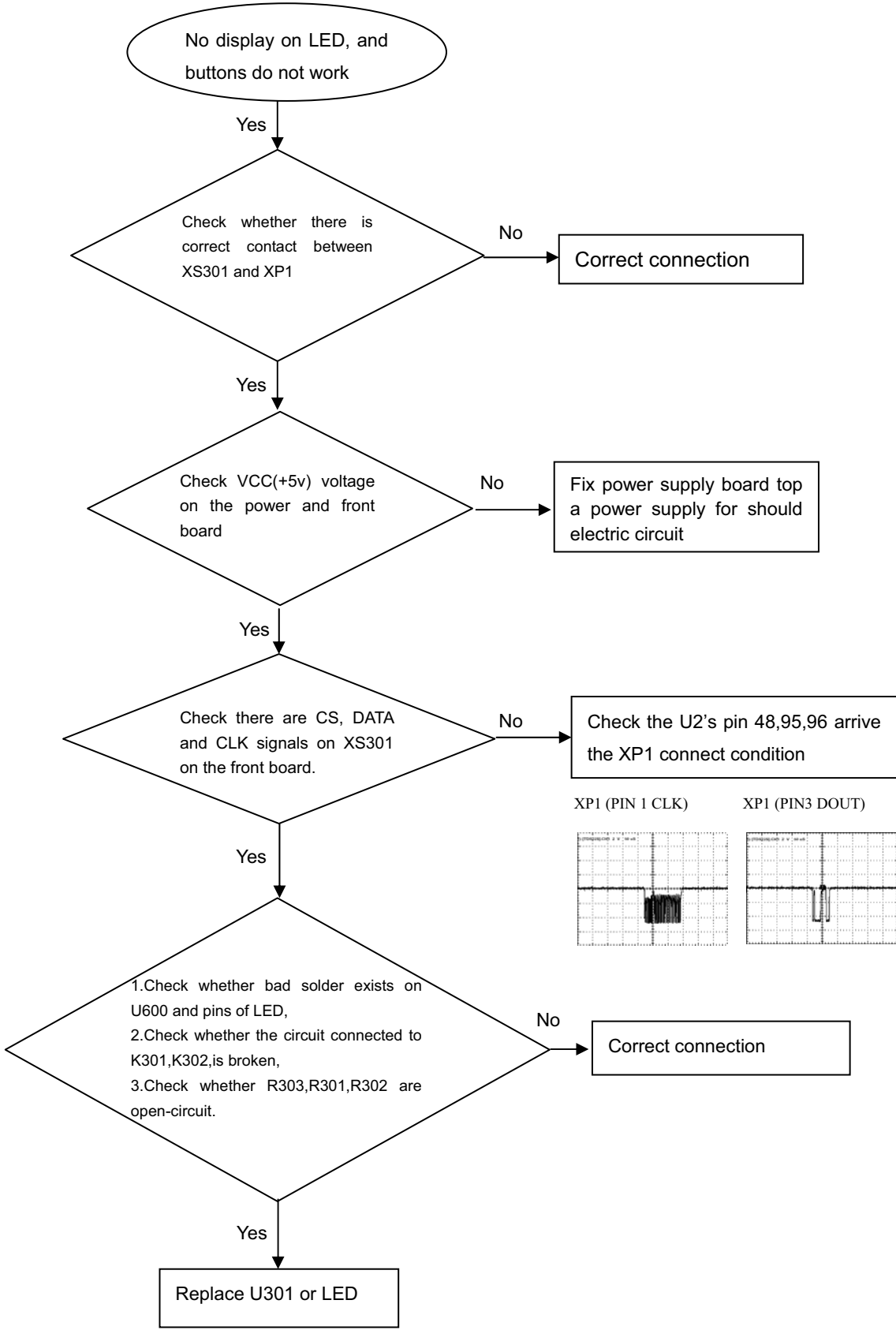

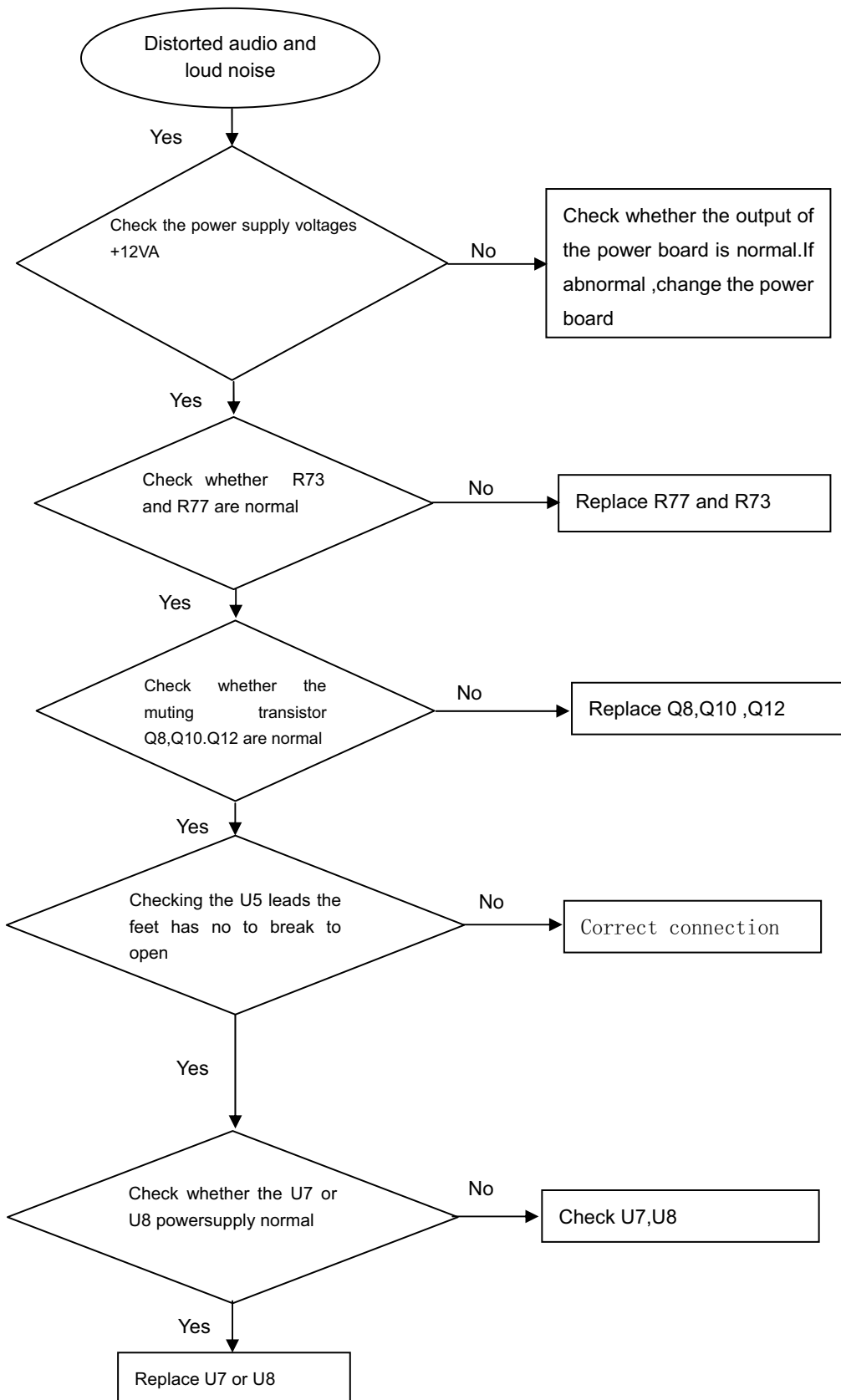
Distorted audio and loud noise

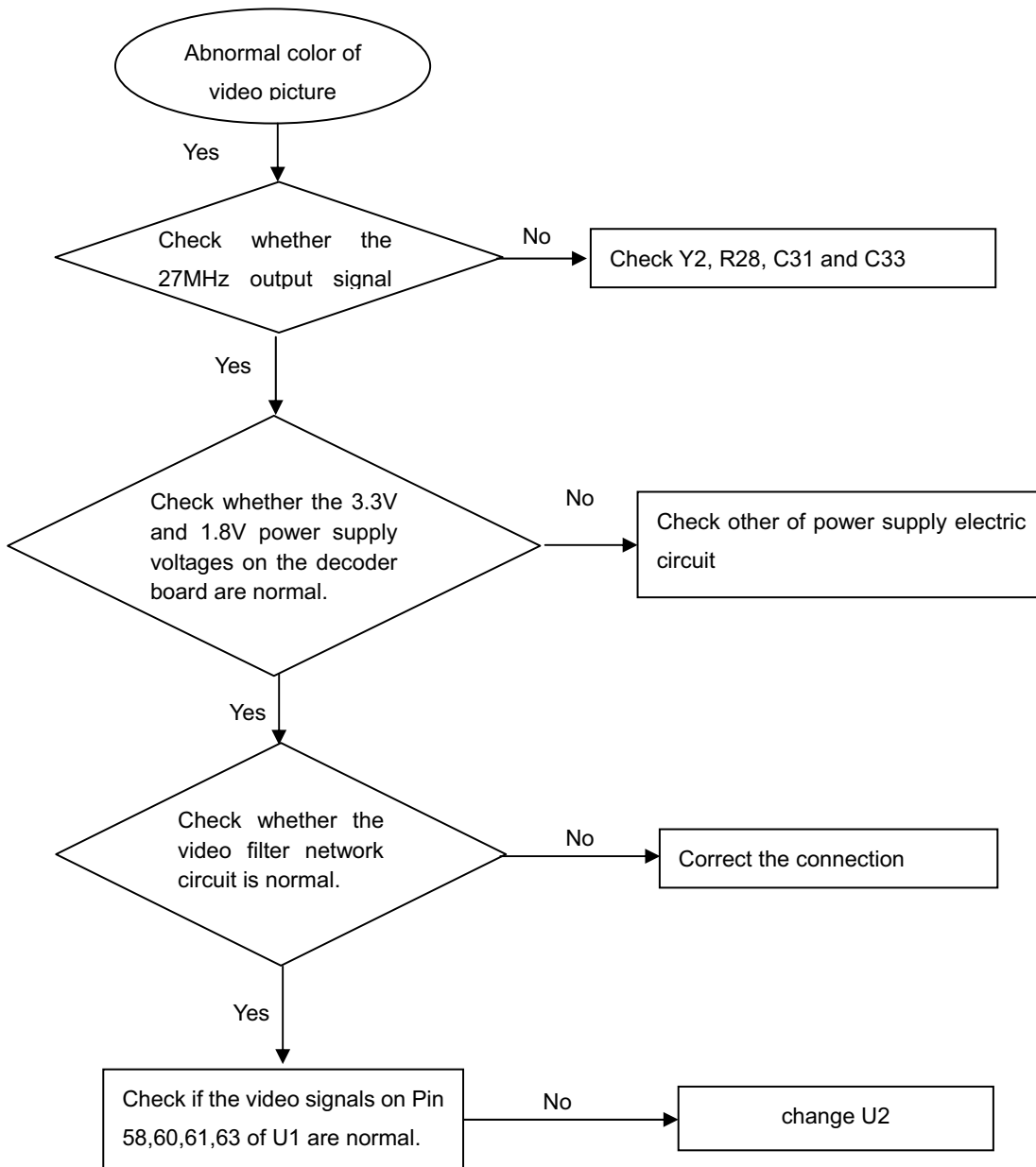
Abnormal color of video picture

Remote reception is insensitive or fails.

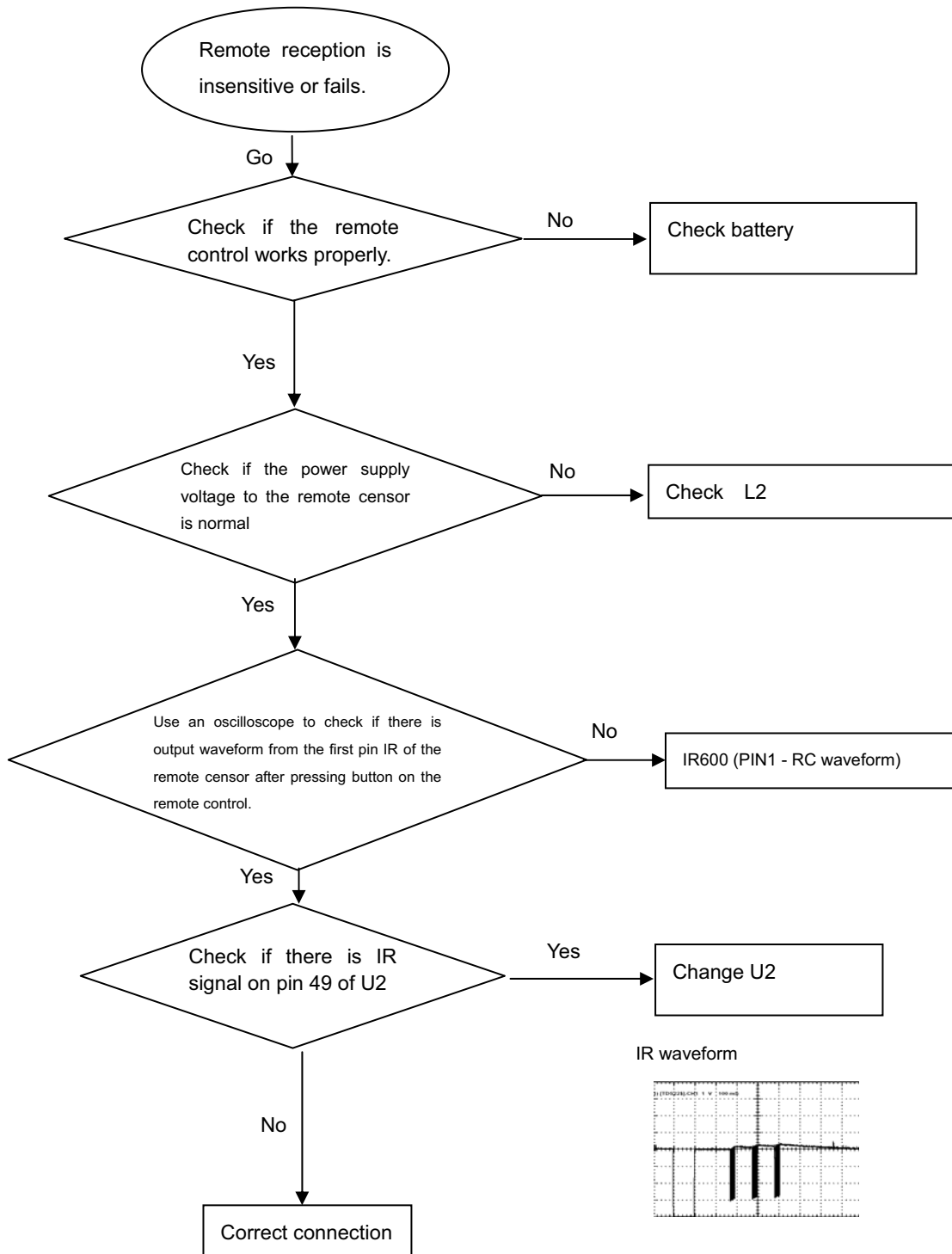

No video picture, no sound.

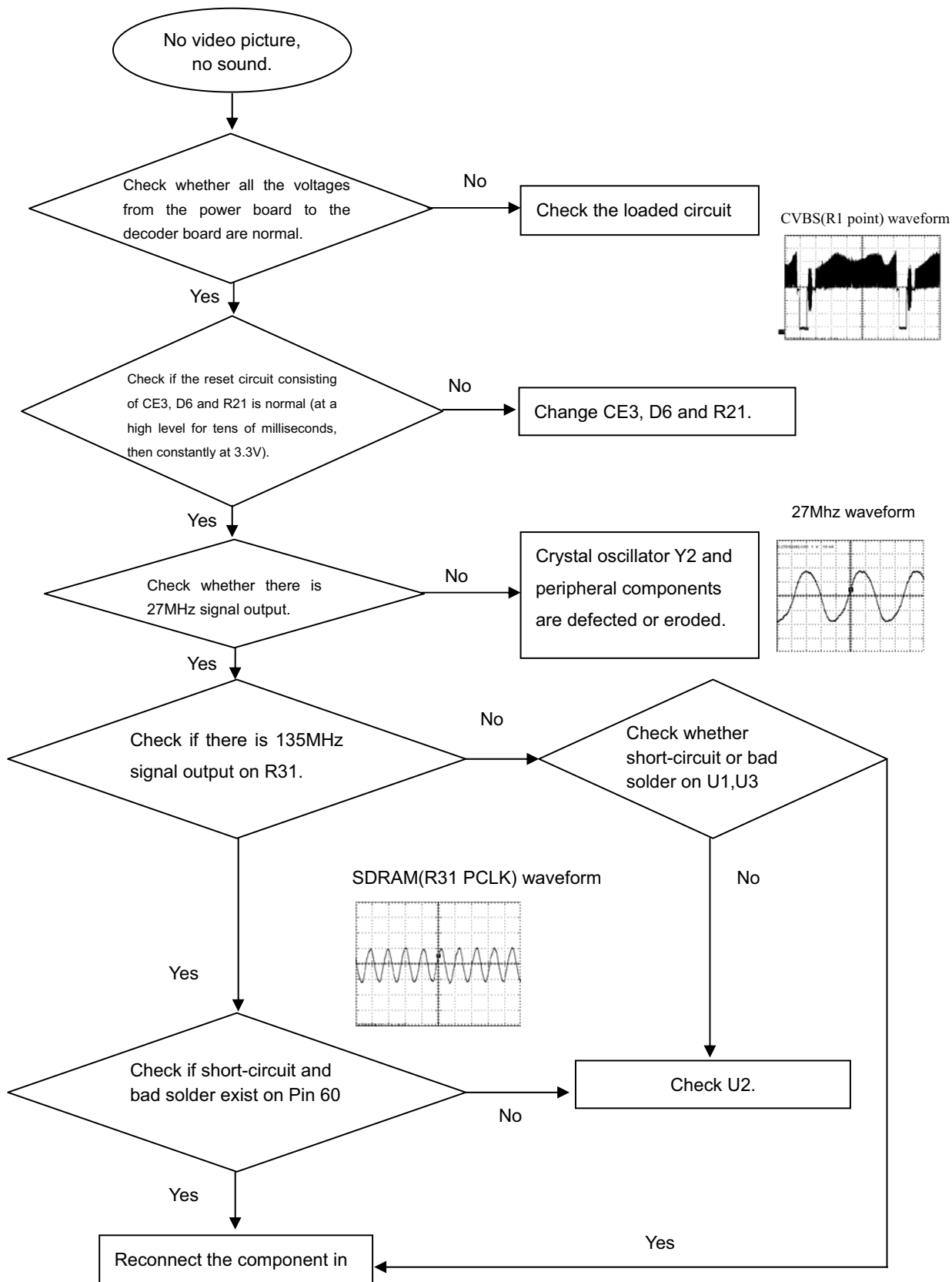

DVP3310 (2CH) WIRING DIAGRAM

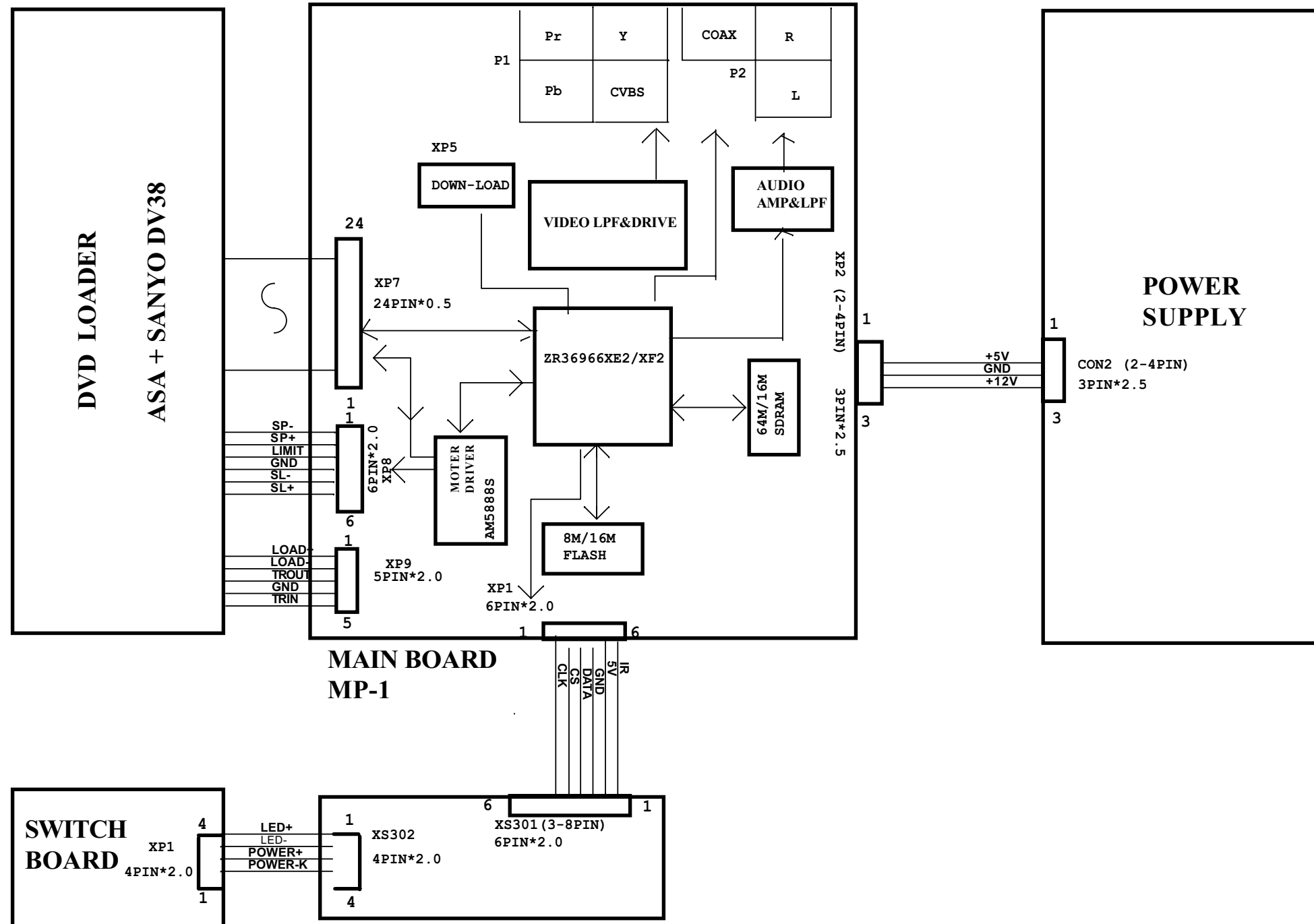

Front Board Electric Diagram for DVP3310:

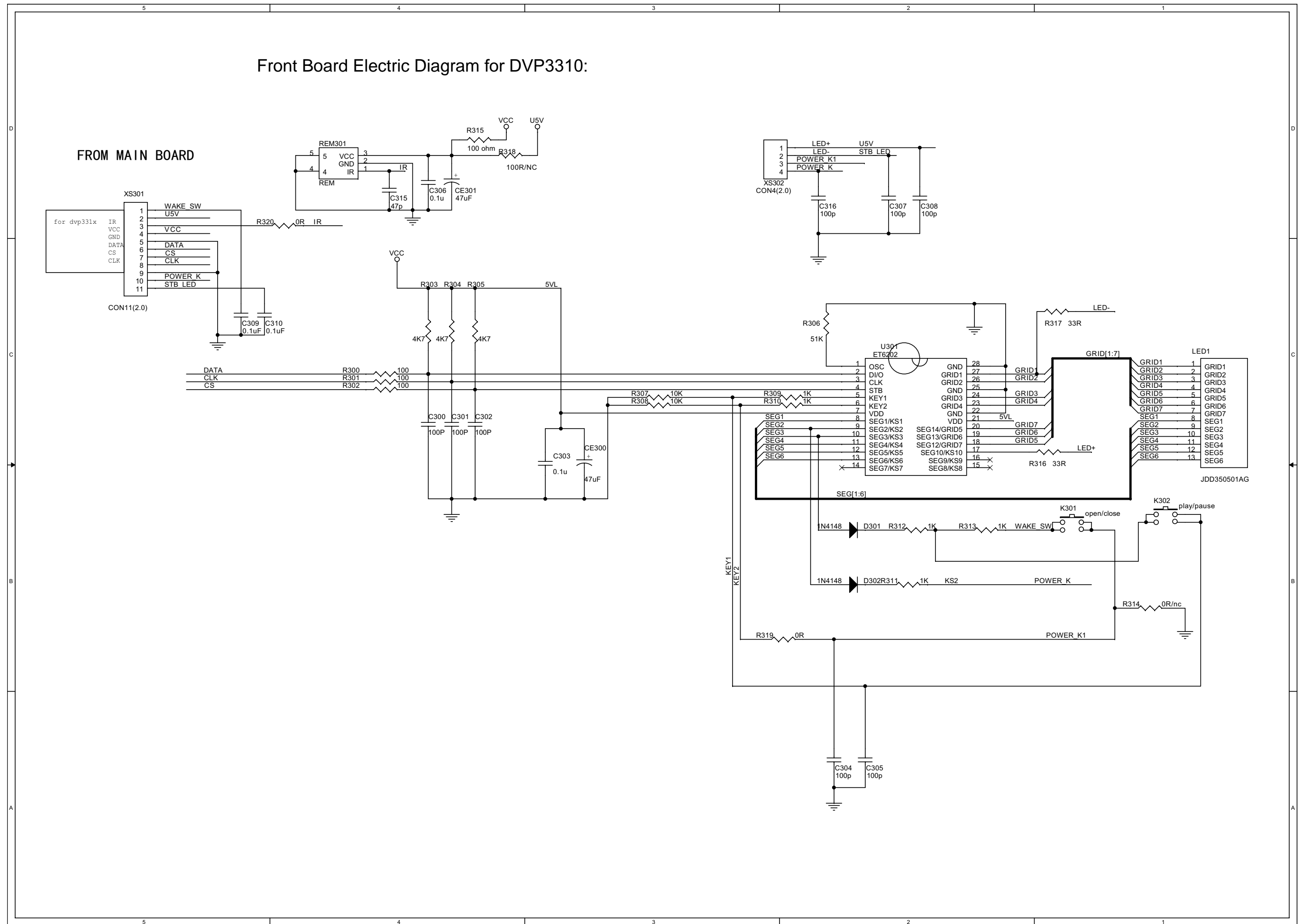

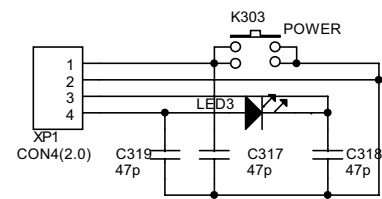

Switch Board Electric Diagram for DVP3310:

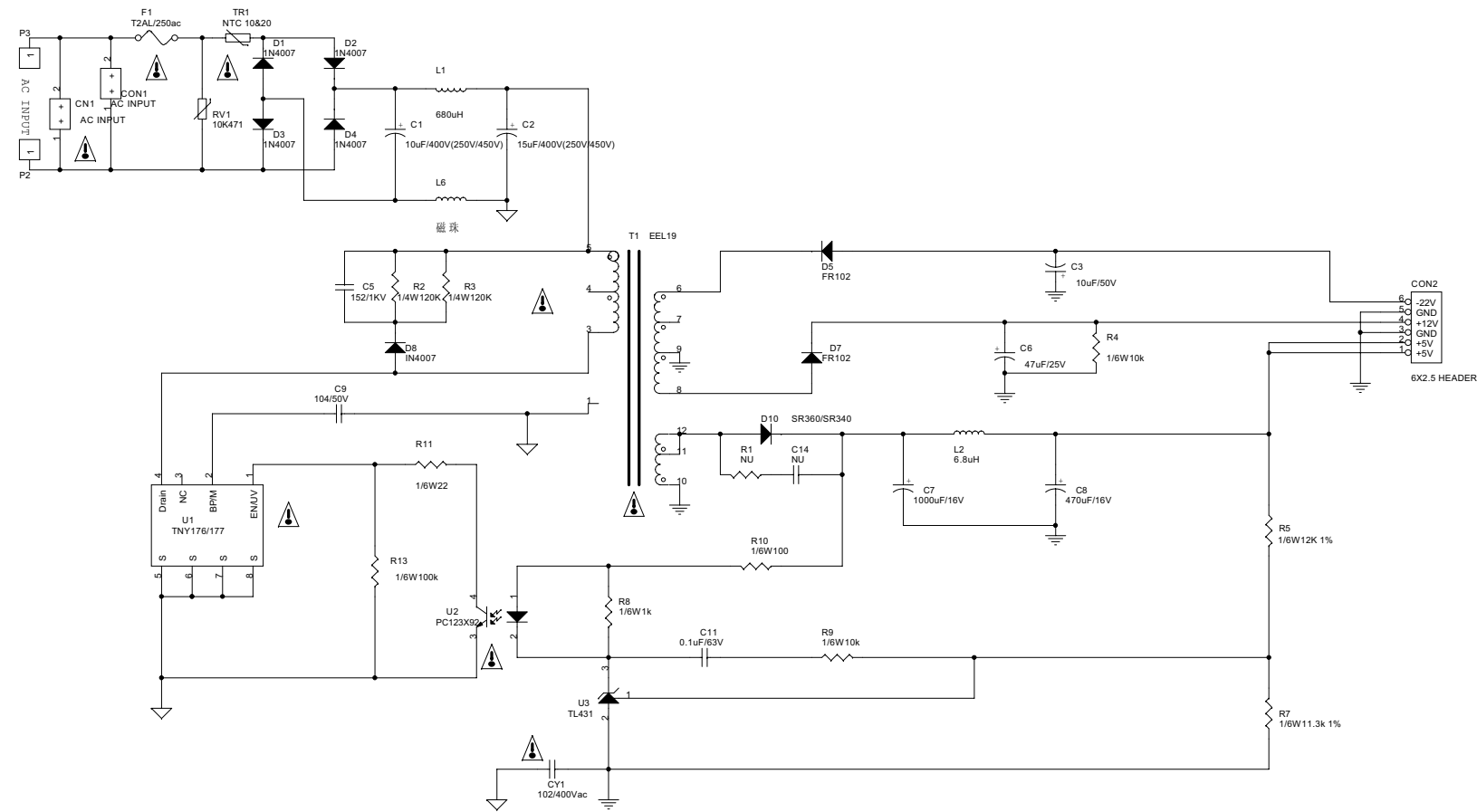

SWITCH BOARD

Power Board Electric Diagram for DVP3310:



*** CAUTION :**
 THE PARTS MARKED WITH  ARE IMPORTANT PARTS ON THE SAFETY.
 PLEASE USE THE PARTS HAVING THE DESIGNATED PARTS NUMBER WITHOUT FAIL.

Main Board Electric Diagram for DVP3310: Power

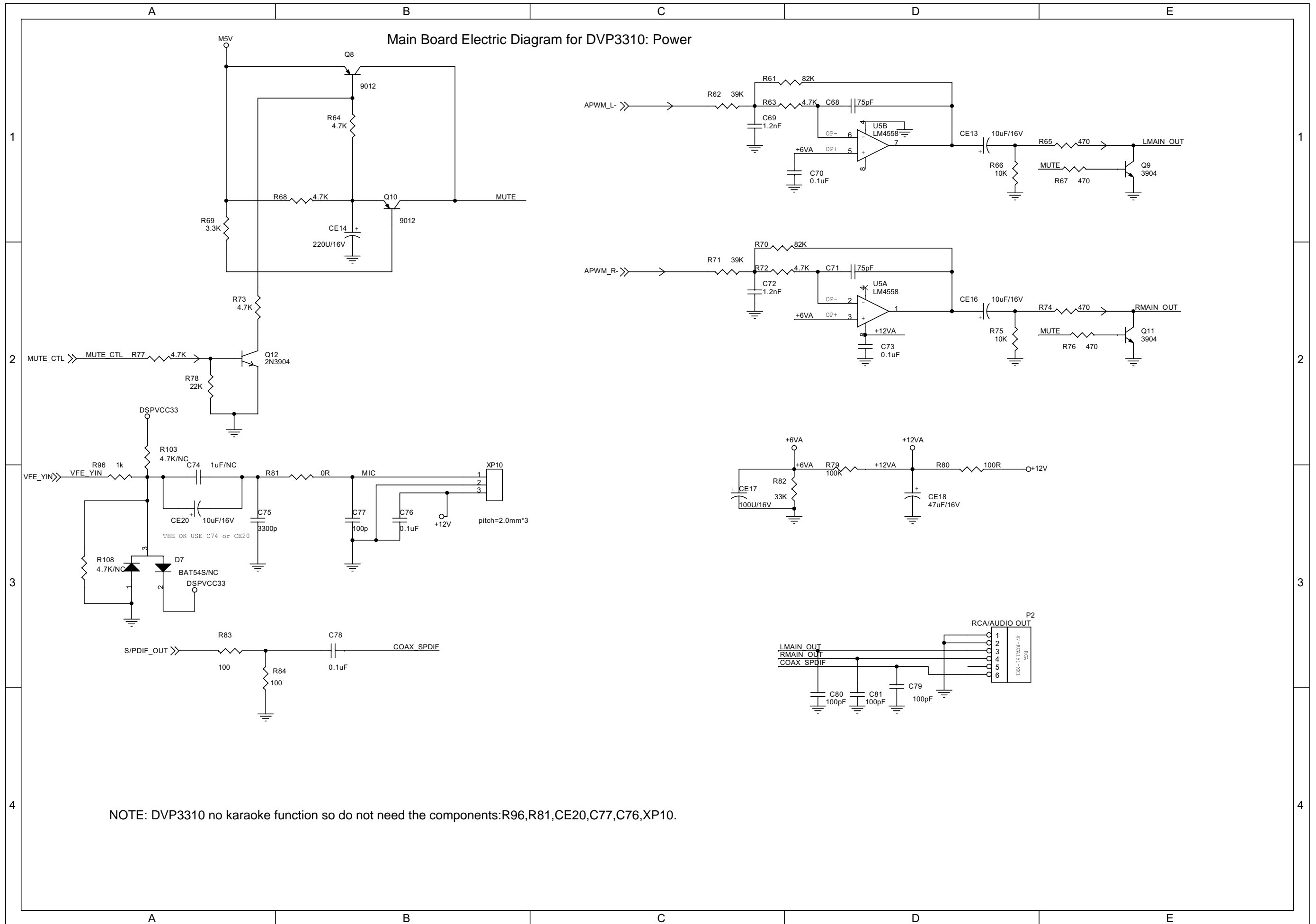

NOTE: DVP3310 no karaoke function so do not need the components:R96,R81,CE20,C77,C76,XP10.

Main Board Electric Diagram for DVP3310: Vaddis_SDRAM_Flash

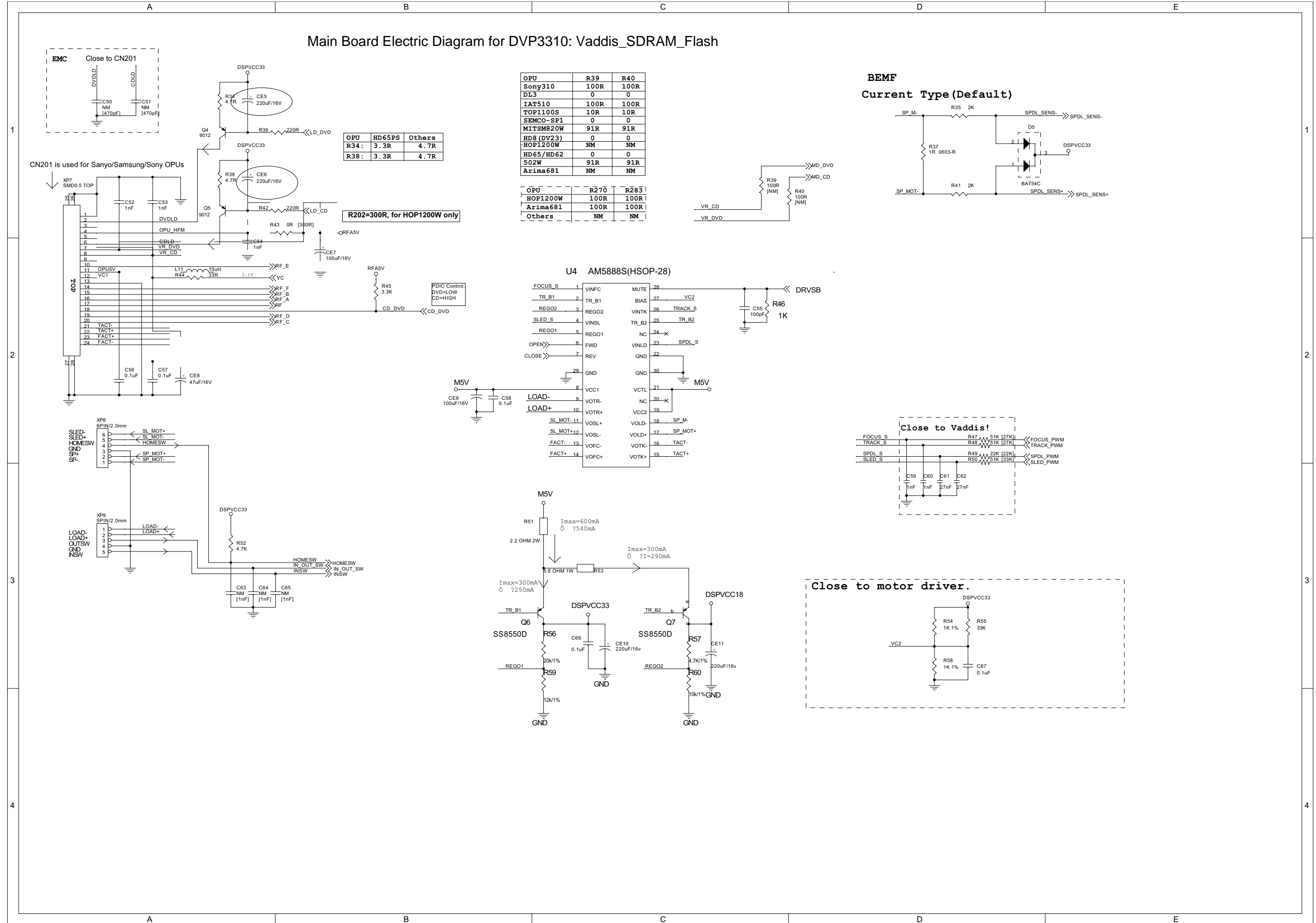

Main Board Electric Diagram for DVP3310: FE_Regulator

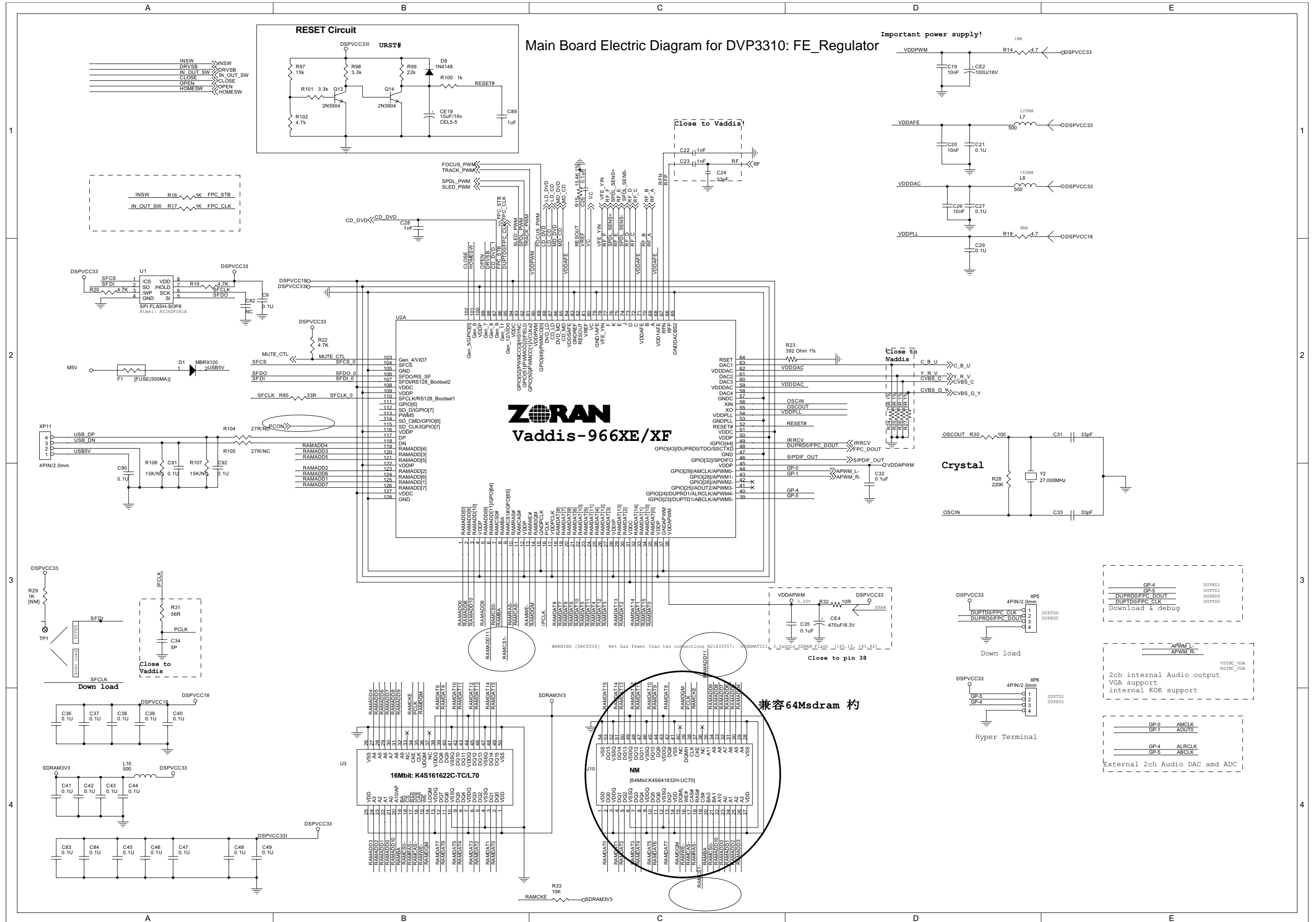

Main Board Electric Diagram for DVP3310: Audio Input Output

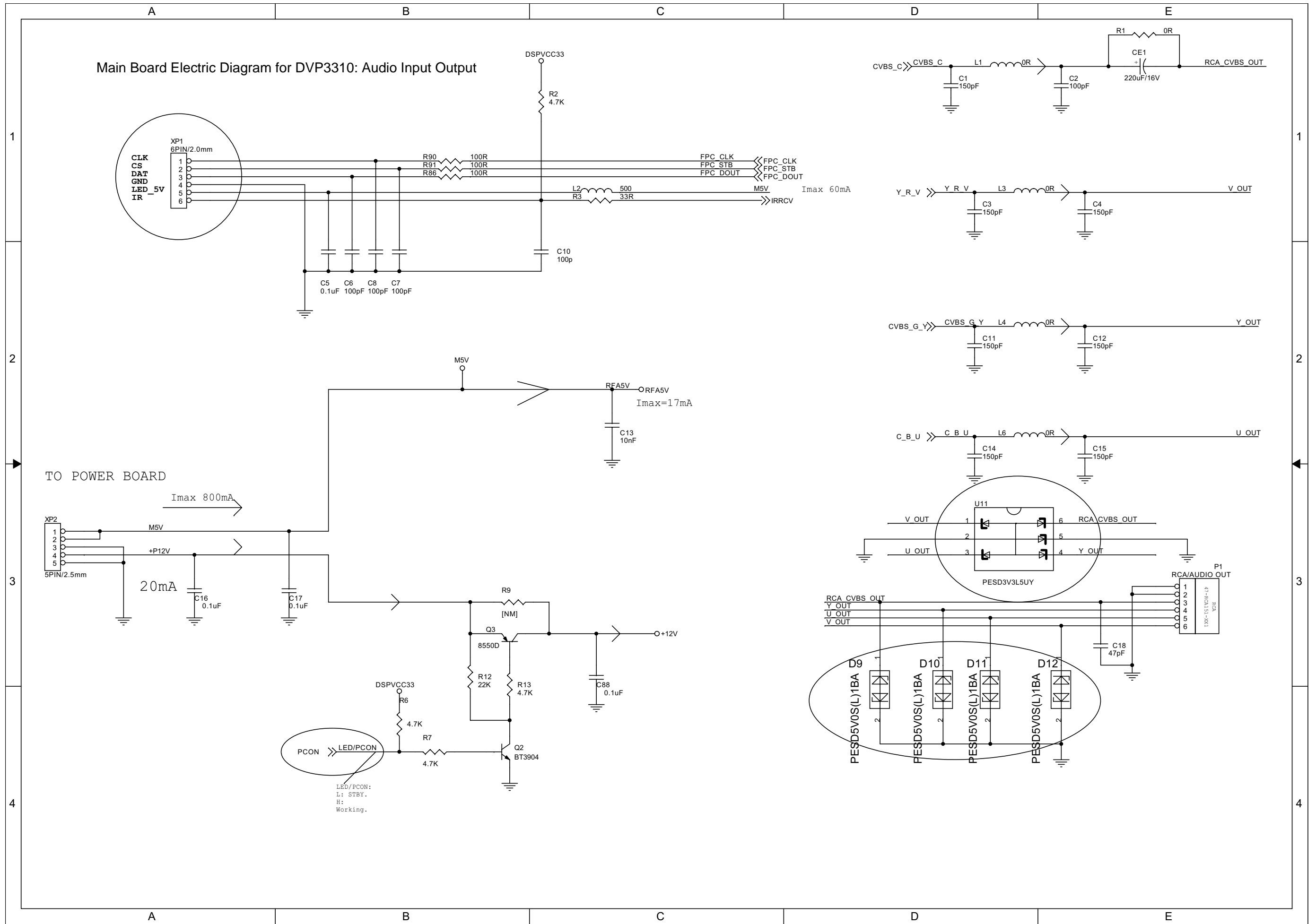

Front Board & Switch Board Print-layout (Bottom side):

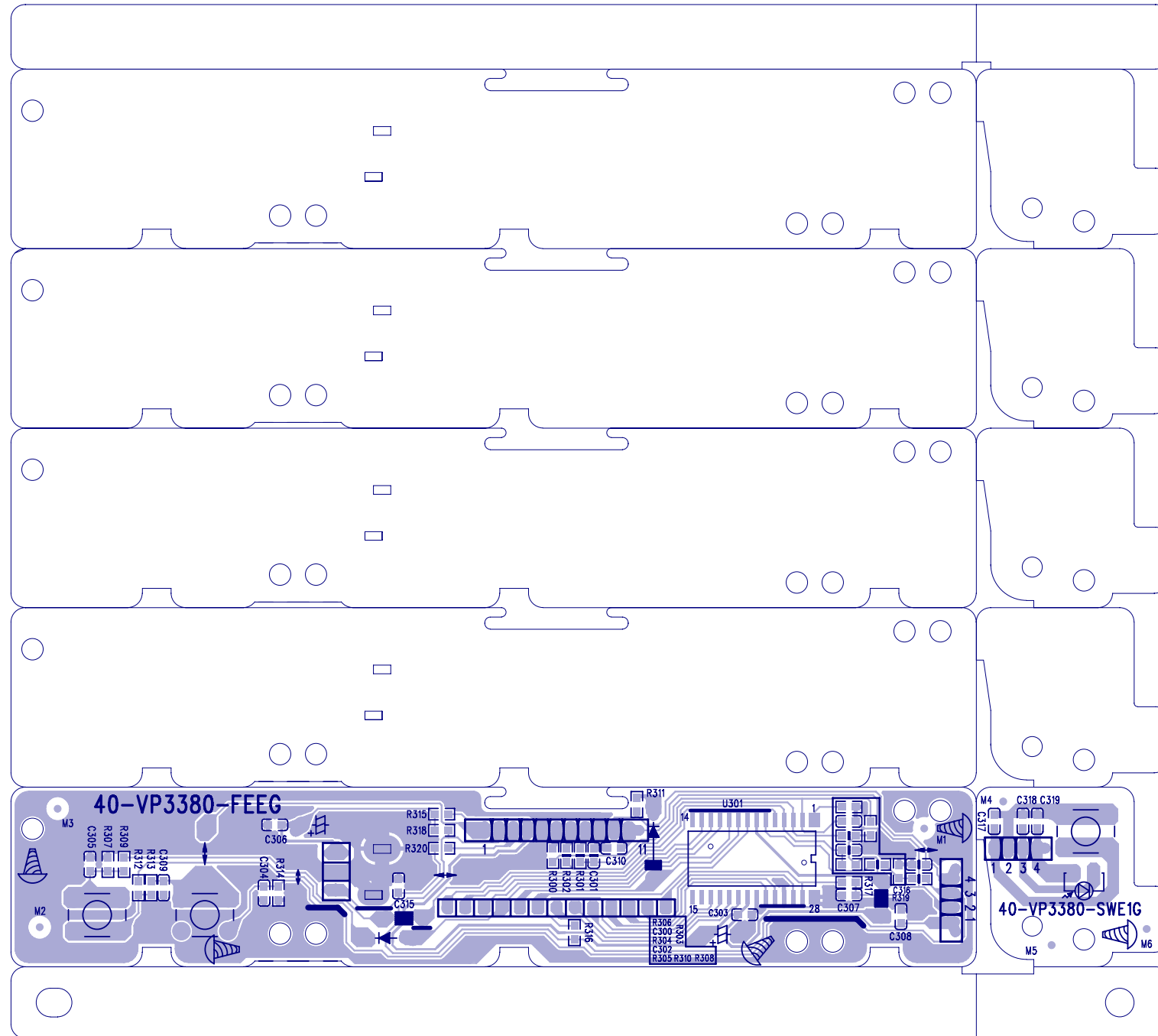

Power Board Print-layout (Bottom side):

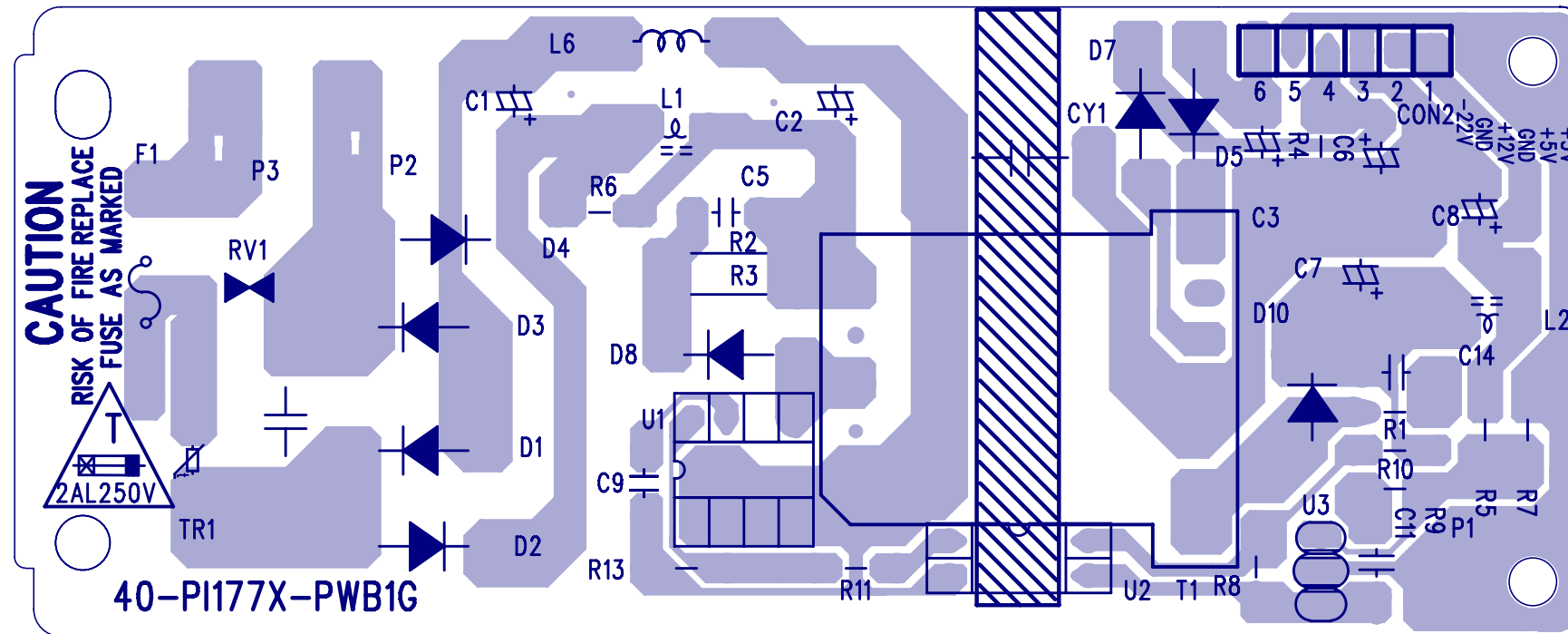

Main Board Print-layout (Top side):

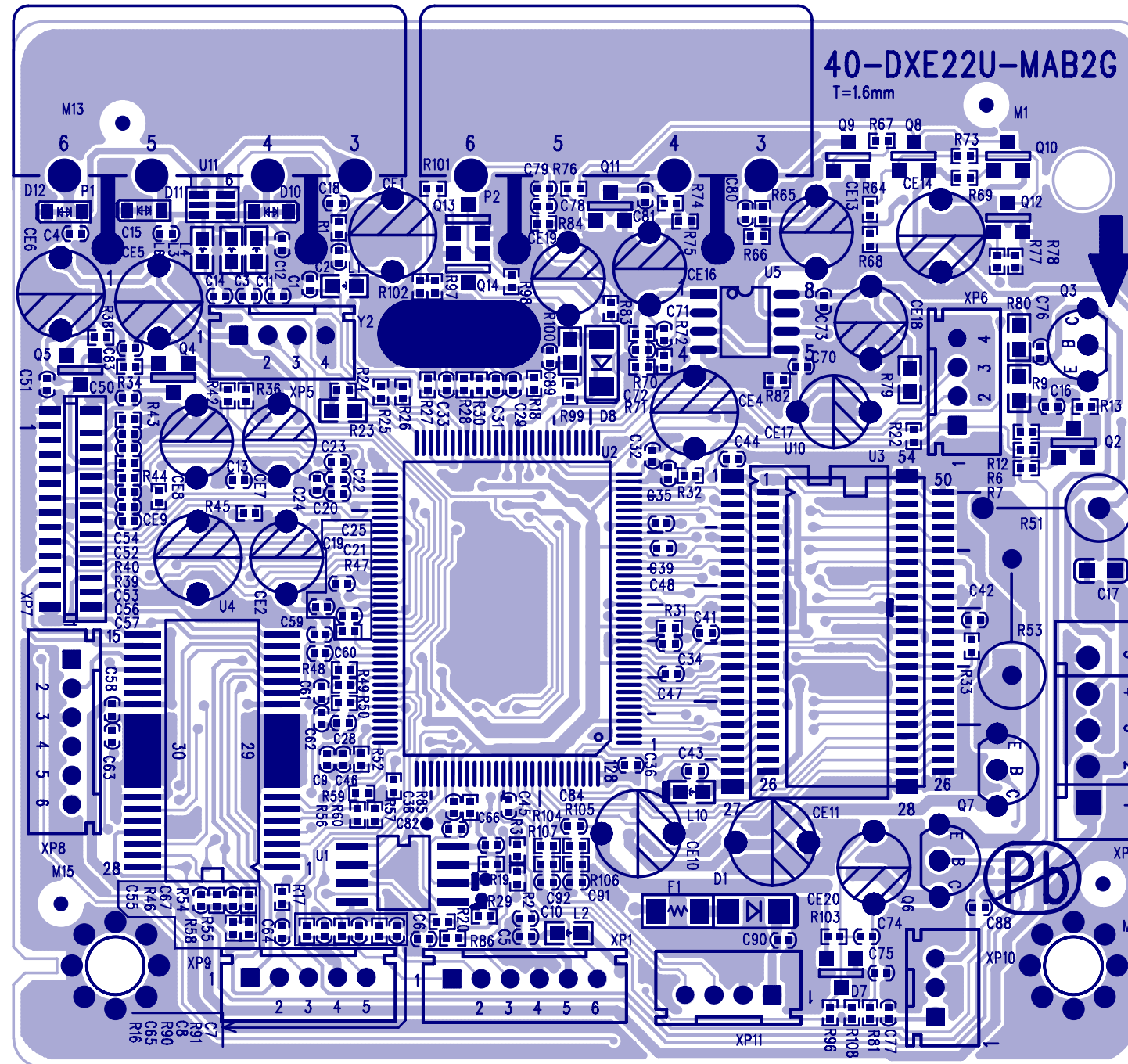

Main Board Print-layout (Bottom side):

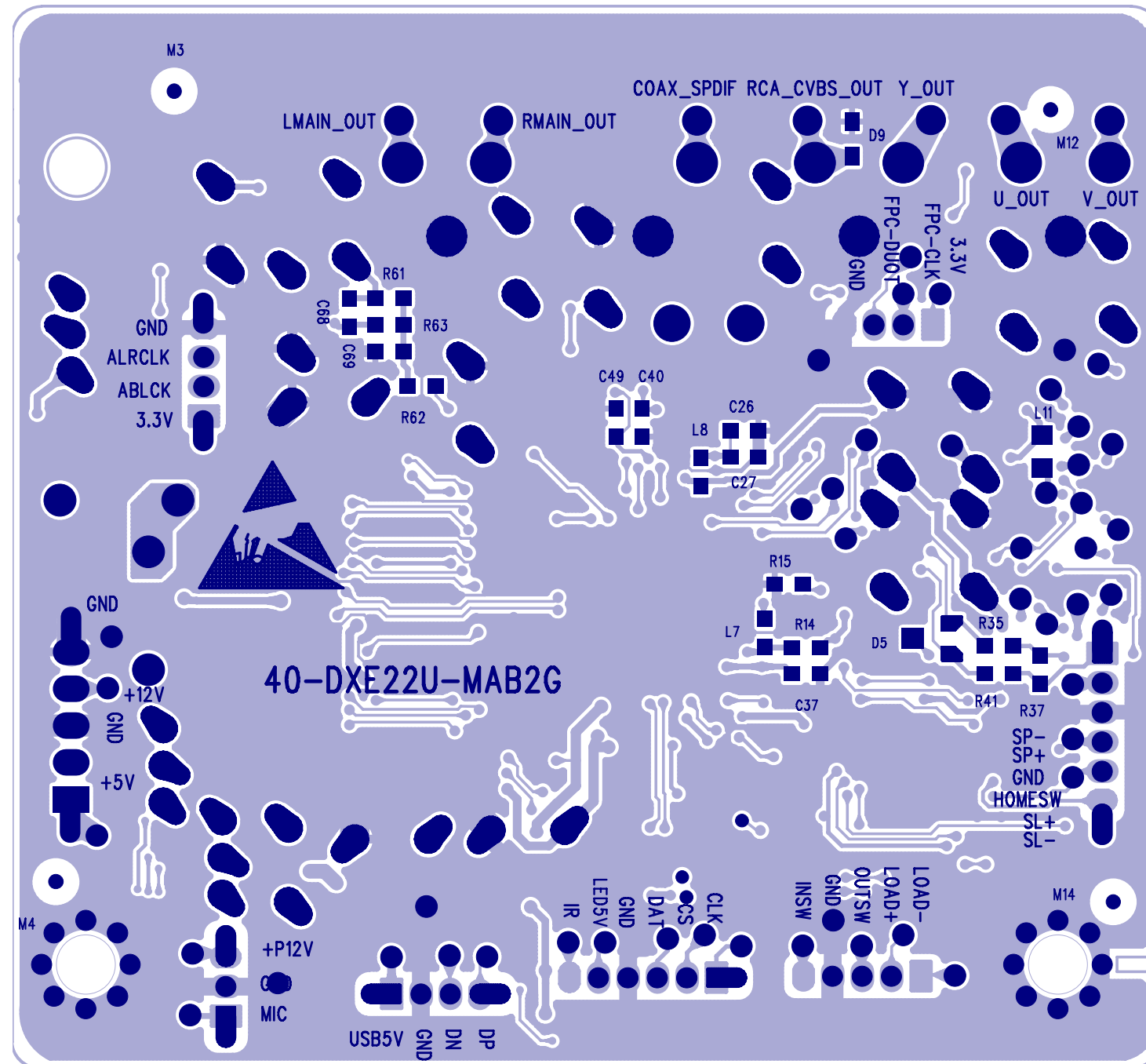

Exploded View for DVP3310/96:

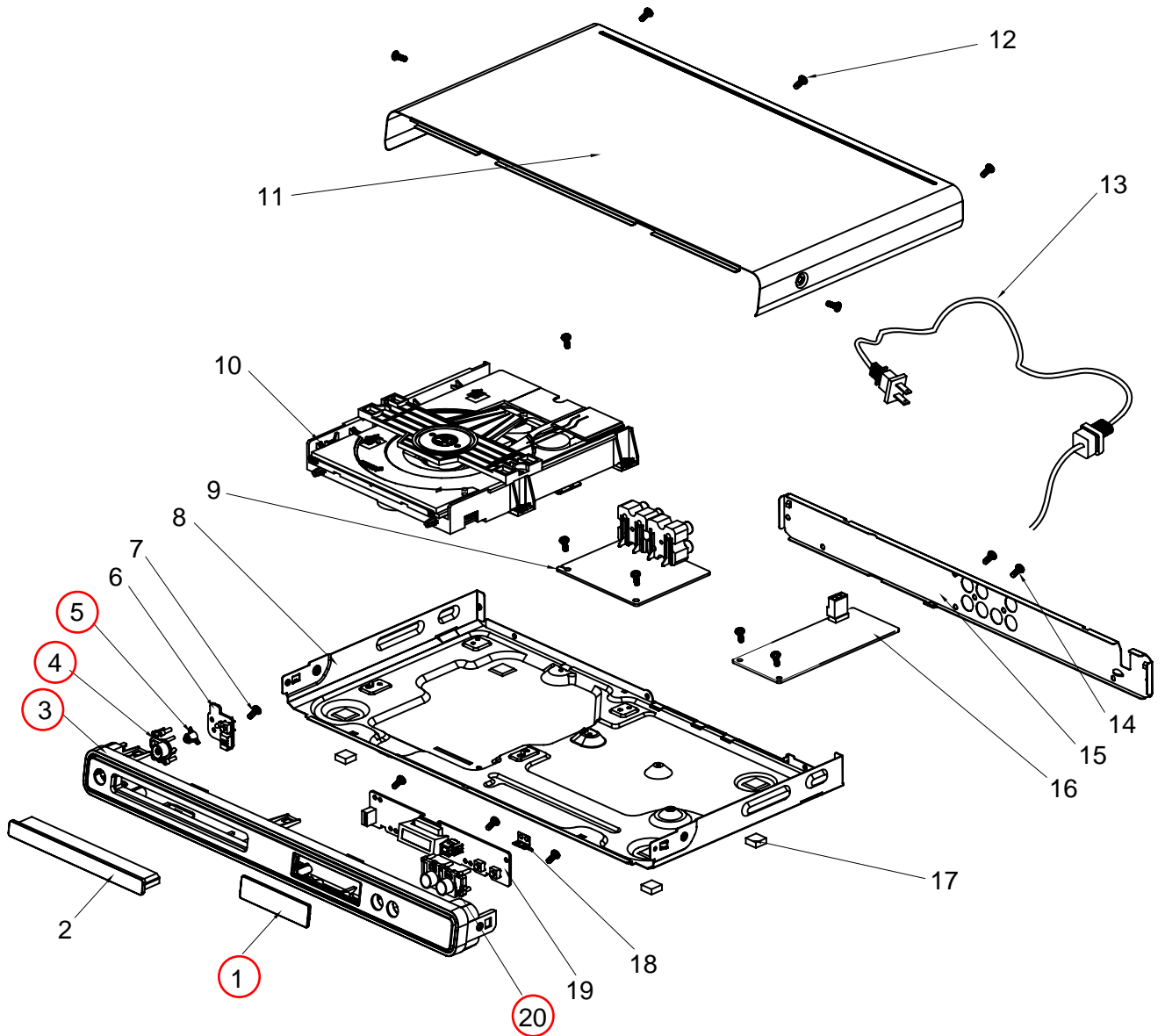

It's a general mechanical exploded view for DVP3310/96, pls refer to the model set for detailed information.

Assy 1 components include:1.3.4.5.20

DVP3310/96 SERVICE PARTLIST

ELECTRICAL PARTLIST

No	12NC No.	Description	Qty
9	996510021486	ASSY-MAIN BD	1
▲ 16	996510021485	ASSY-PW BD	1
19	996510020922	ASSY-FB BD	1
6	996510020934	ASSY-SW BD	1
10	996510021457	LOADER	1
OPU	996510021449	SANYO LOADER (DV38)	1

ASSY-MAIN BD COMPONENT PARTLIST

No	12NC No.	Description	Qty
D5	996510009668	BAT54C	1
D8	996510009667	SMD. SWITCHING DIODE LL4148	1
Q10	996510009670	TRANSISTOR SMT 3CG9012M	1
Q11	996510009669	SMD.TRANSISTOR MMBT3904LT1 NPN	1
Q12	996510009669	SMD.TRANSISTOR MMBT3904LT1 NPN	1
Q13	996510009669	SMD.TRANSISTOR MMBT3904LT1 NPN	1
Q14	996510009669	SMD.TRANSISTOR MMBT3904LT1 NPN	1
Q2	996510009669	SMD.TRANSISTOR MMBT3904LT1 NPN	1
Q3	996510009671	PNP TRANSISTOR	1
Q4	996510021453	SMD. TRANSISTOR MMBT8550CLT1	1
Q5	996510021453	SMD. TRANSISTOR MMBT8550CLT1	1
Q6	996510009671	PNP TRANSISTOR	1
Q7	996510009671	PNP TRANSISTOR	1
Q8	996510009670	TRANSISTOR SMT 3CG9012M	1
Q9	996510009669	SMD.TRANSISTOR MMBT3904LT1 NPN	1
U1	996510021476	16M SPI FLASH AMIC	1
U10	996510013315	64M SDRAM HY57V641620FTP-7-C	1
U11	996510021013	IC PESD5VL4UG	1
U2	996510021459	IC ZR36966PQCG-XE2	1
U4	996510011055	IC CD5888CB	1
U5	996510010924	IC	1
Y2	996510009675	27MCL20PF	1

ASSY-PW BD COMPONENT PARTLIST

No	12NC No.	Description	Qty
D1	996510011047	DIODE IN4007	1
D10	996500027866	DIODE SR360 3A/60V	1
D2	996510011047	DIODE IN4007	1
D3	996510011047	DIODE IN4007	1
D4	996510011047	DIODE IN4007	1
D7	996500014043	DIODE FR102 (FAST RECOVERY)	1
D8	996510011047	DIODE IN4007	1
L1	996510009942	COIL WIDTH	1
L2	996500032509	COIL SL0811-6R8K2R4	1
T1	996510012665	TRANSFORMER CONV.	1
U1	996510010953	IC TNY176PN	1
U2	996500024838	PC123X9YFZ	1
U3	996500014609	IC AM431LP	1

ASSY-FB BD COMPONENT PARTLIST

No	12NC No.	Description	Qty
LED1	996510020917	J2808AG	1
REM301	996510020925	HM338-12 RECEIVER MOD H=12MM	1
U301	996510009665	IC ET6202 SOP-2	1

MECHANICAL PARTLIST

No	12NC No.	Description	Qty
RC	996510020681	REMOTE CONTROL	1
11	996510021483	TOP COVER	1
▲ 13	996510021478	POWER CORD	1
15	996510021496	BACK PANEL	1
17	996510006463	PAD	4
2	996510021487	FRONT DOOR	1
▲ 8	996510020928	BOTTOM PLATE	1
AVCABLE	996510001106	VIDEO CABLE 1500mm	1
ASSY1	996510021484	ASSY - FRONT DOOR	1
CON2	996510021451	HS 3P TJC-3Y/SCN-3Y L=80MM	1
XP7	996510001168	24PIN HS	1
XP8	996510021448	6PIN HS	1
XP9	996510004063	CABLE PH-5Y/PH-5Y L=130MM	1
XS301	996510012698	HS 6P PH-6Y/JC20-6Y 150MM	1

SCREWS LIST:

No	12NC No.	Description	Qty
7	—	S/T SCREW B 2.6 X 8 BF	6
12	—	S/T SCREW B3 X 6 BF	9
14	—	S/T SCREW B 3 X 7 BF	5

REVISION LIST

Version 1.0

* Initial release for DVP3310/96